

INSTRUCTION MANUAL

Sound Level Meter

NL-21 / NL-31



3-20-41 Higashimotomachi, Kokubunji, Tokyo 185-8533, Japan
<http://www.rion.co.jp/english/>

Organization of the NL-21/NL-31 Documentation

The documentation for the Sound Level Meter NL-21/NL-31 consists of three separate manuals.

- **Instruction Manual (this document)**
Describes operating procedures for the Sound Level Meter NL-21/ NL-31, connection and use of peripheral equipment such as a level recorder and printer, and use of the memory card.

- **Serial Interface Manual**
Describes how to use the serial interface built into the Sound Level Meter NL-21/NL-31. The manual covers the communication protocol, use of control commands for the sound level meter, format of data output by the sound level meter, and other topics.

- **Technical Notes**
This document provides in-depth information about the circuit configuration and performance of the sound level meter, microphone construction and characteristics, influence of extension cables and windscreen on the measurement, and other topics.

- * Company names and product names mentioned in this manual are usually trademarks or registered trademarks of their respective owners.

To conform to the EU requirement of the Directive 2002/96/EC on Waste Electrical and Electronic Equipment, the symbol mark on the right is shown on the instrument.

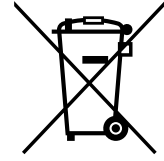

Organization of This Manual

This manual describes the features, operation and other aspects of the General-Purpose Sound Level Meter NL-21 and High-Precision Sound Level Meter NL-31.

The manual contains the following sections.

Outline

Gives basic information about the configuration and features of the unit, and also contains a block diagram.

Controls and Functions

Briefly identifies and explains the controls and connectors and all other parts of the unit.

Preparations

Gives information about power supply, pre-use checks, installation, connections, key settings etc.

Reading the Display

Explains the symbols and other information appearing on the display of the unit.

Power On/Off

Explains how to turn the unit on and off.

Measurement

Explains how to perform measurement.

Store Operations

Explains how to store measurement results in the memory of the unit.

Memory Card

Explains how to use memory cards with the unit.

Default Settings

Lists the factory default settings of the unit.

Output Connectors

Explains the output connectors of the unit.

Optional Accessories

Explains how to use external equipment for example to store measurement data.

Messages

Explains the various messages that may appear on the screen.

Specifications

Lists the technical specifications of the unit.

FOR SAFETY

In this manual, important safety instructions are specially marked as shown below. To prevent the risk of death or injury to persons and severe damage to the unit or peripheral equipment, make sure that all instructions are fully understood and observed.



Disregarding instructions printed here incurs the risk of injury to persons and/or damage to peripheral equipment.

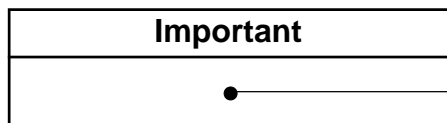

Disregarding instructions printed here incurs the risk of damage to the product.

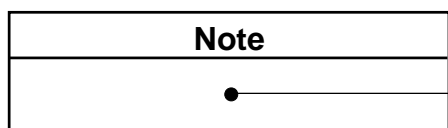

Mentioned about the tips to use this unit properly. (This messages do not have to do with safety.)

Precautions

- Operate the unit only as described in this manual.
- Protect the unit from shocks and vibration. Be especially careful not to touch the microphone membrane to avoid damage. The membrane is an extremely thin metal film which can be damaged easily.
- Do not use the unit with a different microphone/preamplifier from the one indicated on the name plate of the unit.
- Ambient conditions for operation of the unit are as follows: temperature range -10 to +50°C, relative humidity 10 to 90%.
Protect the unit from water, dust, extreme temperatures, humidity, and direct sunlight during storage and use. Also keep the unit away from air with high salt or sulphur content, gases, and stored chemicals.
- Always turn the unit off after use. Remove the batteries from the unit if it is not to be used for a long time. When disconnecting cables, always grasp the plug and do not pull the cable.
- Before using the microphone and before putting it away, always check that the microphone grid has not become loose. If this has happened, refasten the microphone grid firmly and then use or store the microphone.
- Clean the unit only by wiping it with a soft, dry cloth or, when necessary, with a cloth lightly moistened with water. Do not use any solvents, cleaning alcohol or cleaning agents.
- Do not try to disassemble the unit.
In case of an apparent malfunction, do not attempt any repairs. Note the condition of the unit clearly and contact the supplier.
- Do not tap the LCD panel or other surfaces of the unit with a pointed object such as a pencil, screwdriver, etc.
- Take care that no conductive objects such as wire, metal scraps, conductive plastics etc. can get into the unit.
- To ensure continued precision, have the unit checked and serviced at regular intervals.
- When disposing of the unit, be sure to observe all applicable legal regulations and guidelines in your country and community.

Quantifier Notation of Sound Level Meter NL-21/NL-31 According to International Standards and JIS

(Excerpts from ISO 1996, 3891, IEC 61672-1:2002, JIS Z 8202, 8731)

NL-21 / 31 notation	Description	Frequency weighting	ISO notation	IEC notation	JIS notation
L_p	Sound pressure level	Flat	L_p	—	L_p
L_A	A-weighted sound level	A	L_{pA}	—	L_{pA}
L_C	C-weighted sound level	C	—	—	—
L_{peq}	Equivalent continuous sound level	Flat	—	—	—
L_{Aeq}	Equivalent continuous A-weighted sound level	A	$L_{Aeq,T}$	$L_{Aeq,T}$	$L_{Aeq,T}$
L_{Ceq}	Equivalent continuous C-weighted sound level	C	—	$L_{Ceq,T}$	—
L_{pE}	Sound exposure level	Flat	—	—	—
L_{AE}	A-weighted sound exposure level	A	L_{AE}	$L_{AE,T}$	L_{AE}
L_{CE}	C-weighted sound exposure level	C	—	—	—
L_{AN}	Percentile A-weighted sound level	A	$L_{AN,T}$	—	$L_{AN,T}$
L_{A05}			$L_{A5,T}$	—	$L_{A5,T}$
L_{A10}			$L_{A10,T}$	—	$L_{A10,T}$
L_{A50}			$L_{A50,T}$	—	$L_{A50,T}$
L_{A90}			$L_{A90,T}$	—	$L_{A90,T}$
L_{A95}	$L_{A95,T}$	—	$L_{A95,T}$		
L_{Amax}	Maximum A-weighted sound level	A	—	—	—
L_{Amin}	Minimum A-weighted sound level	A	—	—	—
L_{Cpk}	Waveform peak sound pressure level	C	—	L_{Cpeak}	—

Contents

FOR SAFETY	v
Outline	1
Controls and Functions	4
Front View	4
Operation Keys	5
Bottom View	8
Rear View	9
Preparations	10
Power Supply	10
Windscreen (WS-10)	13
Tripod Mounting	13
Memory Card, Program Card	14
Microphone Extension Cables (EC-04 series).....	15
Connection to a Printer (DPU-414, CP-11, CP-10).....	17
Connection to a Level Recorder (LR-06, LR-07, LR-04, LR-20A).....	20
Connection to a Computer	20
Setting the Date and Time	21
Measurement in Dark Locations	23
LCD Contrast.....	24
Calibration	25
Language selection	30
Reading the Display	31
Display screen.....	31
Menu screens	36
Power On/Off	45

Measurement	47
Sound level Measurement	47
Equivalent Continuous Sound level (L_{Aeq}) Measurement	50
Sound Exposure Level (L_{AE}) Measurement	55
Maximum (L_{max}) and Minimum (L_{min}) Sound level Measurement	60
Percentile Sound level (L_N) Measurement	65
Measurement of Auxiliary Processing Values (L_{peak} , L_{Cpeak} , L_{Ceq} , L_{Atm5} , L_{AI} , L_{Aeq})	71
Back-Erase Function	77
Store Operations	79
Manual Store	81
Auto 1	89
Auto 2	95
Memory Card	103
Memory Card	103
Data size	104
Store Data Format	106
Default Settings	111
Output Connectors	112
AC Output	112
DC Output	113
I/O Connector	114
Optional Accessories	115
Microphone Extension Cables EC-04 Series	115
Printer DPU-414/CP-11/CP-10	116
Level Recorder LR-06/LR-07/LR-04/LR-20A	124
Program Cards	126
Messages	136
Specifications	141

Outline

The Sound Level Meter NL-21 and NL-31 are designed for sound level measurements according to the IEC standard.

The following measurements can be made:

- Equivalent continuous sound level L_{eq}
- Sound exposure level L_E
- Maximum sound level L_{max}
- Minimum sound level L_{min}
- Percentile sound level L_N (five selectable settings)
- Sound level L_p
- C-weighted peak sound level L_{Cpeak}
- FLAT peak sound level L_{peak}
- Impulse sound level L_{AI}
- Impulse equivalent continuous sound level L_{AIeq}
- Takt-max sound level L_{Atm5}

Measurement settings and results (level values and bar graph) are shown on the backlit LCD panel.

Measurement data (sound level, processed data, measurement parameters) can be stored in the internal memory of the unit or on a memory card (CompactFlash card optional). The serial interface allows sending measurement data to a printer or computer.

By loading an optional filter program, the unit can be used for 1/1 octave or 1/3 octave analysis with a 3rd-order Butterworth high-pass and low-pass filter.

Recorded data can be further processed on a computer.

The following accessories are optional, to cover a wide range of application requirements.

- Printer DPU-414
Serves to produce hard copy of measurement data (including data stored in memory).
- Level recorder LR-07/LR-20A
Serves to record sound level changes over time.

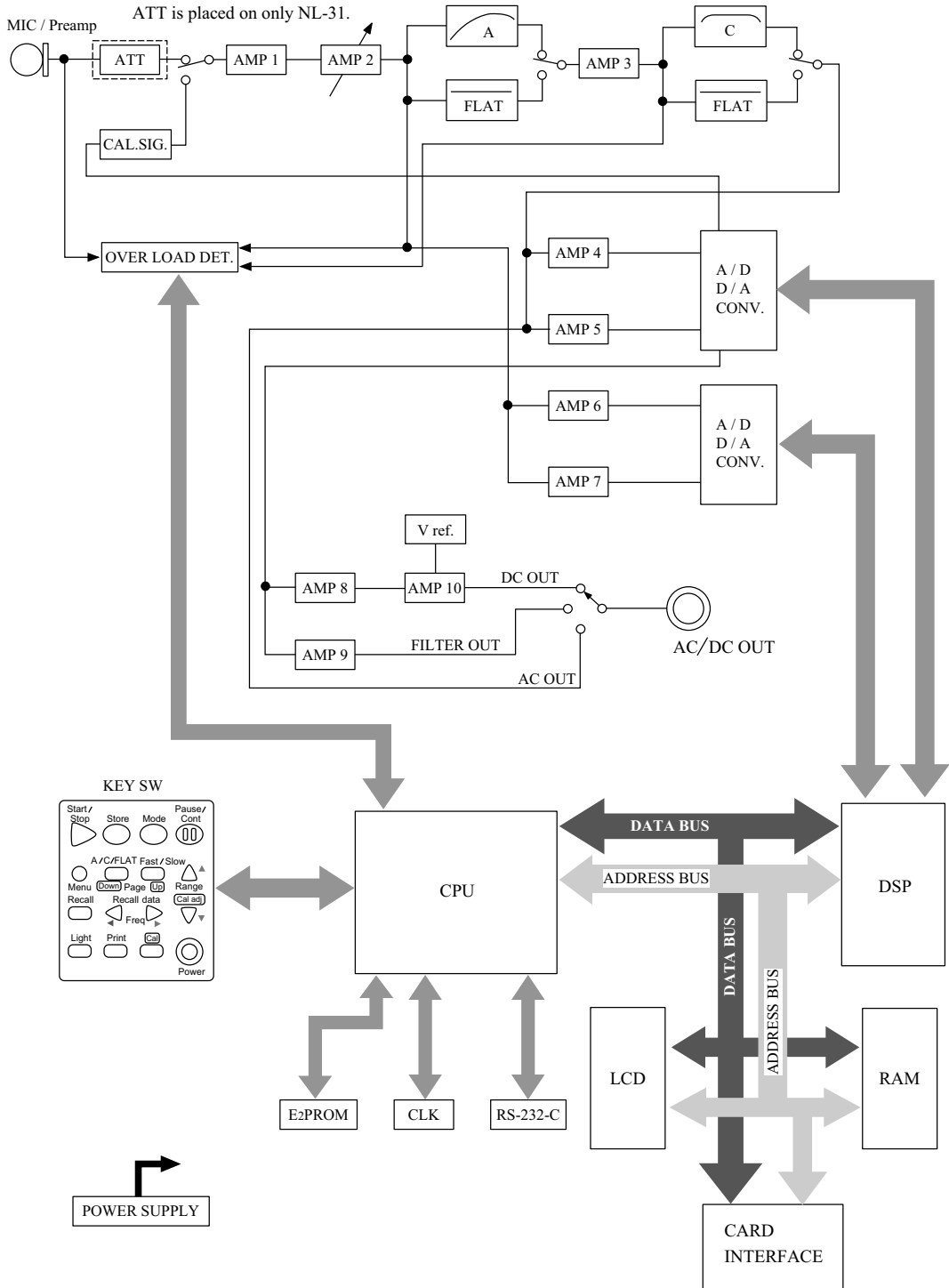

NL-21 / NL-31 Block Diagram

Controls and Functions

Front View

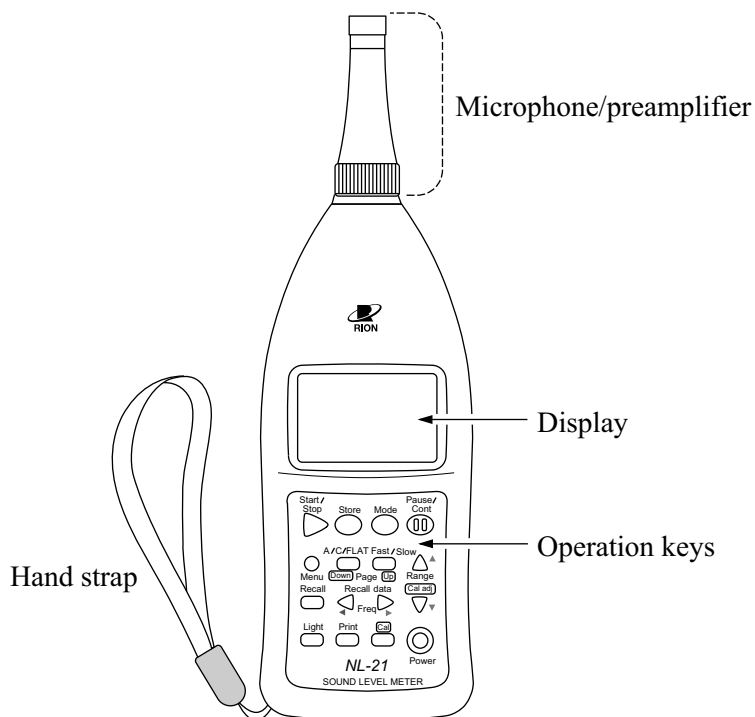

Microphone/preamplifier

The microphone and preamplifier are configured as an integrated assembly. The assembly can be removed from the sound level meter and connected via an optional extension cable, for measurements a distance.

Display

This backlit LCD shows the sound level as a numeric reading and a bar graph. The display also shows the operation mode of the sound level meter, the selected measurement parameters, warning indications etc.

Hand strap

Makes the unit easy to carry and hold on your palm.

Operation Keys

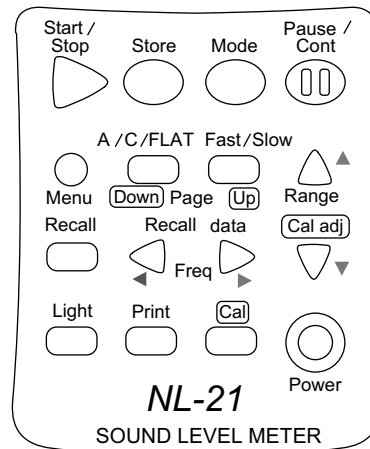

Start/Stop key

Press to start or stop the sound level measurement (including the various processing functions).

Store key

Press to start auto store or store measurement data using manual store.

Mode key

This key is used for reading the measurement results. With each push of the button, the display format is switched according to the processing types selected from the menu.

Pause/Cont key

During a measurement, this key can be used to exclude unwanted portions from processing. Pressing the key again causes processing to be resumed.

It is also possible to use the key for excluding an interval of up to 5 seconds before the key was pressed.

Menu key

When this key is pressed, the menu screen 1/5 appears on the display. Pressing the key again switches the display back to the original condition.

Menu pages are switched with the Page keys to the right of the key.

A/C/FLAT key

Sets frequency weighting to A, C or FLAT.

Fast/Slow key

Sets the time weighting to Fast or Slow.

Level Range ▲ , ▼keys

Select the level range for the measurement.

The following six settings are available:

20 to 80, 20 to 90, 20 to 100, 20 to 110, 30 to 120, 40 to 130

With the filter function activated, the following seven settings are available:

10 to 70, 20 to 80, 30 to 90, 40 to 100, 50 to 110, 60 to 120, 70 to 130

Recall key

Serves to recall data stored in the memory of the unit.

Recall Data ◀ , ▶ keys

When the display shows the measurement screen and the manual store mode is selected, these keys select the data number in which to store data next.

When the display shows data from memory, the keys select the data number to be displayed. When the filter function is active, this key serves to switch filter frequencies.

Light key

This key activates the backlight for easier viewing of the display in low-light conditions. To turn the backlight off, press the key once more.

When the automatic light out function was selected from the menu, the light will turn itself off automatically after 5 minutes.

Print key

When the optional printer DPU-414, CP-11, or CP-10 is connected, pressing this key initiates a printout.

Cal key

Pressing this key activates the built-in oscillator for electrical calibration of the unit or for level matching of the unit and connected equipment.

Power key

Turns the unit on and off when you hold the key down for more than 1 second.

Hand strap

Attach the carrying strap to the unit as shown below. The strap makes it easier to carry the unit and serves as a precaution against dropping it. Pass the strap over your wrist, as shown in the illustration.

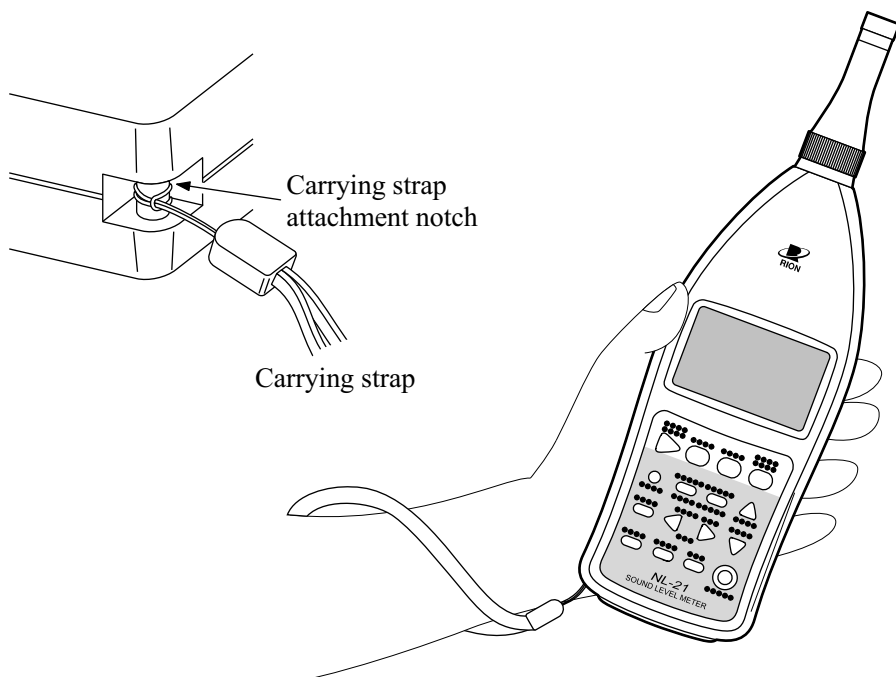

Using the hand strap

Bottom View

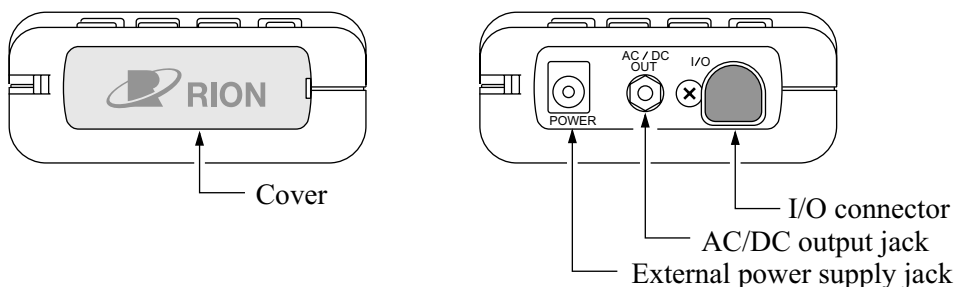

Cover

This cover protects the connectors on the bottom during transport or storage. Removing the cover gives access to the connectors shown above.

External power supply jack

The optional AC adapter NC-98A, NC-34 series can be connected here for powering the unit from an AC outlet.

Important

To prevent the risk of damage, do not use any AC adapter other than the specified type.

AC/DC output jack

The signal selected on menu screen 3/5 is output here.

AC: AC signal (with frequency weighting)

DC: DC signal corresponding to sound level

I/O connector

This input/output connector serves for input of control signals and input/output of measurement data. A printer, level recorder, or computer can be connected here.

Rear View

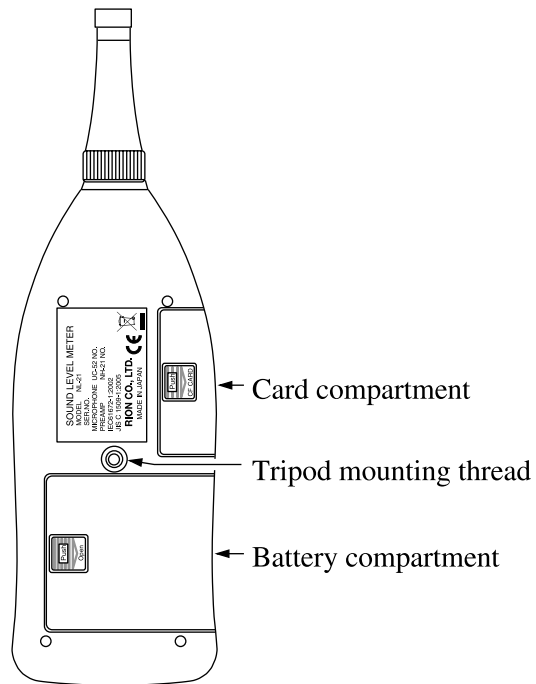

Card compartment

An optional memory card (CompactFlash™ card) can be inserted here.

Tripod mounting thread

The unit can be mounted on a camera tripod using this thread.

Battery compartment

Four batteries (IEC R6P, size AA) are inserted here.

Preparations

Power Supply

The unit can be powered by four IEC R6P (size AA) batteries (alkaline or manganese) or by the specified optional AC adapter.

It is possible to use size AA rechargeable batteries, but a separate recharger must be provided for such batteries, since the unit is not designed to recharge batteries.

Note

When the AC adapter is connected, the unit will be powered from the adapter, also when batteries are inserted. (The AC adapter has priority.)

In case of a power failure or other interruption of AC power, the unit will automatically switch to battery power and continue to operate.

Inserting the batteries

1. Lightly press the cover of the battery compartment and slide it to the right.
2. Insert the four IEC R6P batteries, paying attention to the polarity as indicated in the compartment.
3. Replace the cover.

Lightly press here and slide to the right

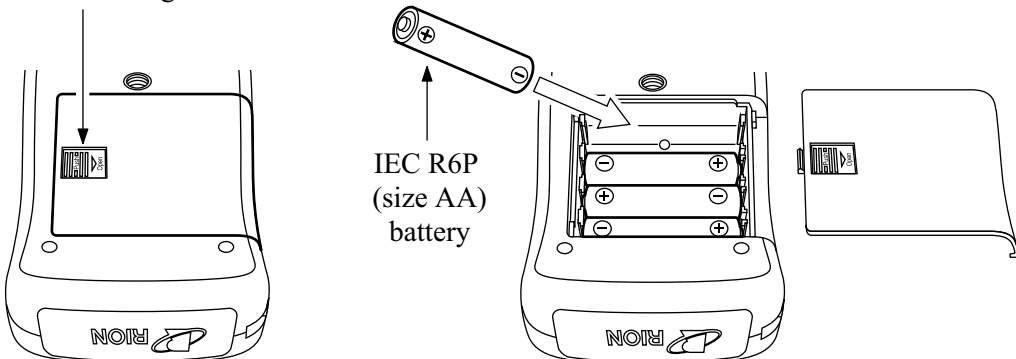

The life of a set of batteries depends on usage conditions and various other factors. Some reference values are shown below.

Battery life (23°C)

		Continuous use
NL-21	Alkaline batteries LR6	Approx. 32 hours
	Manganese batteries R6P	Approx. 12 hours
NL-31	Alkaline batteries LR6	Approx. 27 hours
	Manganese batteries R6P	Approx. 10 hours

When display backlighting is used, battery life will be about half of the above values.

When auxiliary processing is ON, battery life will be about 20 percent shorter.

When the optional filter is activated, battery life will be about 20 percent shorter.

Important
<p>Take care not to reverse the (+) and (-) polarity when inserting the batteries.</p> <p>Always replace all four batteries together.</p> <p>Do not mix old and new batteries or batteries of different type.</p> <p>Remove the batteries from the unit, if the unit is not to be used for a month or longer.</p>

AC adapter (option)

Connect the AC adapter as shown below.

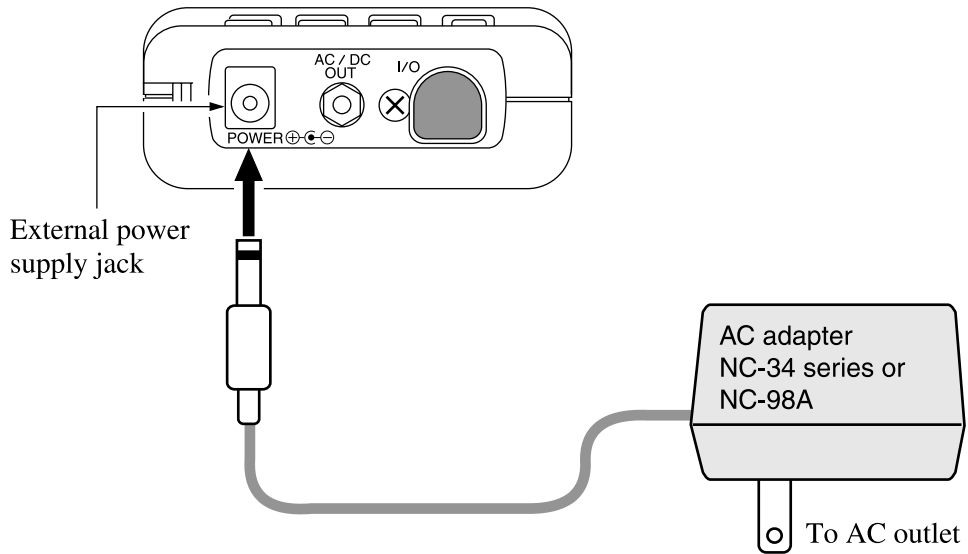

Important

To prevent the risk of damage, do not use any AC adapter other than the NC-98A or NC-34 series (both available as options).

Windscreen (WS-10)

When making outdoor measurements in windy weather or when measuring air conditioning equipment or similar, wind noise at the microphone can cause measurement errors. Such effects can be reduced by using the windscreen WS-10.

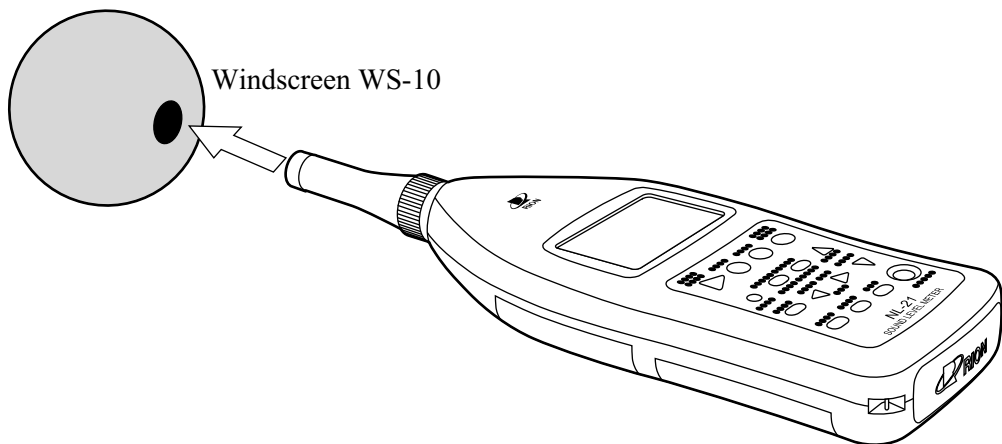

Tripod Mounting

For long-term measurements, the unit can be mounted on a camera tripod. Proceed carefully, to avoid dropping the unit or tipping over the tripod.

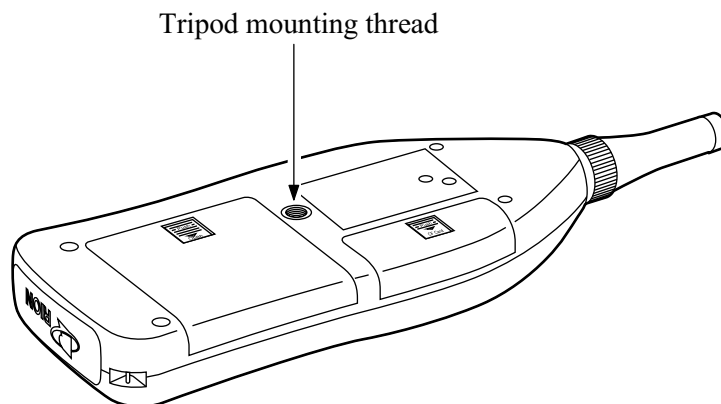

Memory Card, Program Card

Measurement data can be stored on a memory card (CompactFlash card), and data on the card can later be used in a computer for further processing. Program cards which are memory cards containing software are also available. By loading the software into the NL-21/NL-31, a 1/1 octave or 1/3 octave filter or a 3rd-order Butterworth high-pass and low-pass filter by 1/3-octave step become available.

Inserting and removing a card

1. Open the cover of the card compartment.
2. Load the card.
Take care not to try inserting the card with wrong orientation. Push the card in carefully, until it is properly seated.
3. To remove the card, push the lever in. The card will emerge from the slot.
For information on how to load software from a program card, please refer to page 126.

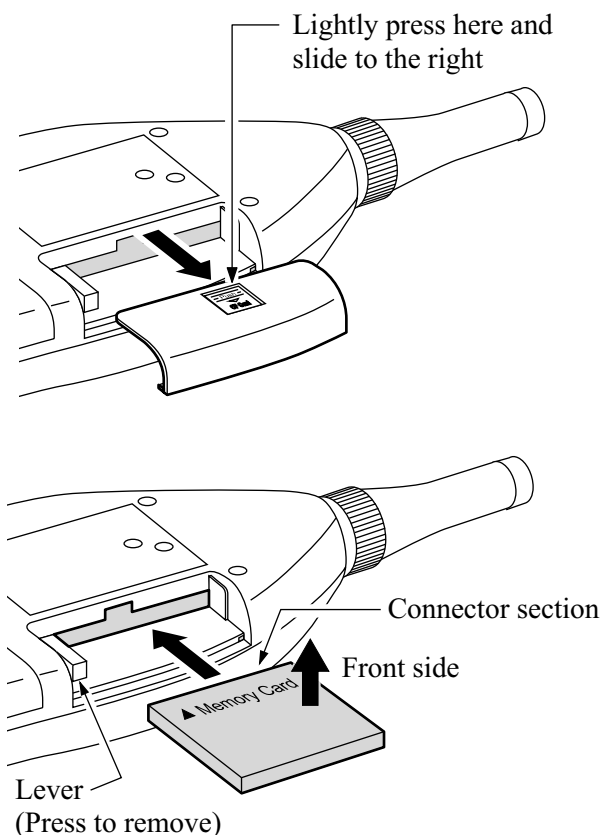

Important

Be sure to turn the unit off before inserting and removing the card from the unit.

Microphone Extension Cables (EC-04 series)

Turn power to the unit off before separating the microphone from the main unit.

To reduce measurement deviations due to refraction effects and the acoustic influence of the operator, the microphone can be detached from the unit and connected via an extension cable. Optional cables are listed in the table below. It is also possible to connect several cables in series.

Extension cable EC-04 series

Model	Length	Model	Length
EC-04	2 m	EC-04C	30 m (reel) + 5 m (connection cable)
EC-04A	5 m	EC-04D	50 m (reel) + 5 m (connection cable)
EC-04B	10 m	EC-04E	100 m (reel) + 5 m (connection cable)

Important

With long extension cables, the cable capacitance restricts the upper measurement frequency and measurement level. For details, please refer to the Technical Notes.

1. Loosen the preamplifier fastening screw and remove the preamplifier from the main unit.

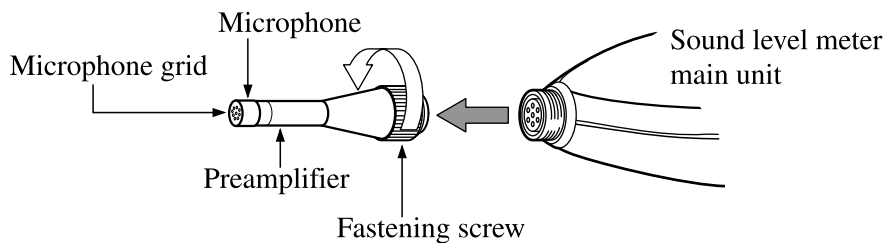

Important

Never separate the microphone and preamplifier, because this can lead to damage.

Important (NL-31 only)

Never remove the microphone grid, because this can lead to damage.

Before using the microphone and before putting it away, always check that the microphone grid has not become loose. If this has happened, refasten the microphone grid firmly and then use or store the microphone.

2. Connect the extension cable to the preamplifier and to the main unit and fasten the connectors with the fastening screw.
3. When mounting the microphone on a tripod, first fasten the microphone holder (supplied with the extension cable) to the tripod. Then insert the extension cable connector into the microphone holder.

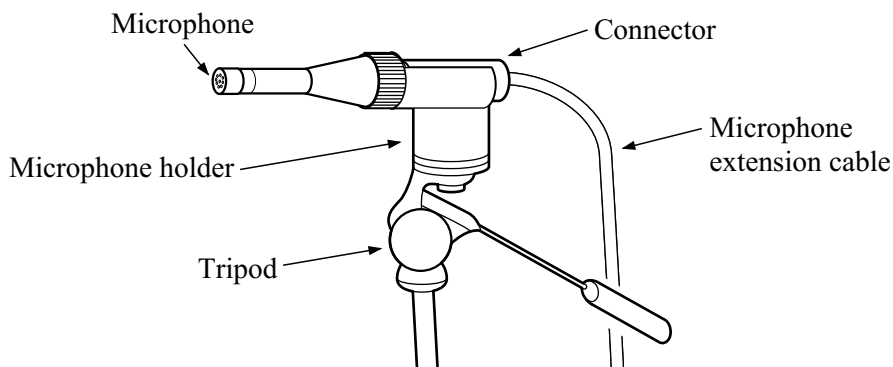

Connection to a Printer (DPU-414, CP-11, CP-10)

The I/O port on the bottom of the unit can be used for connection of an optional printer (DPU-414, CP-11, CP-10). Use the optional printer cable CC-93 or CC-93A to connect the I/O port of the unit to the serial input of the printer.

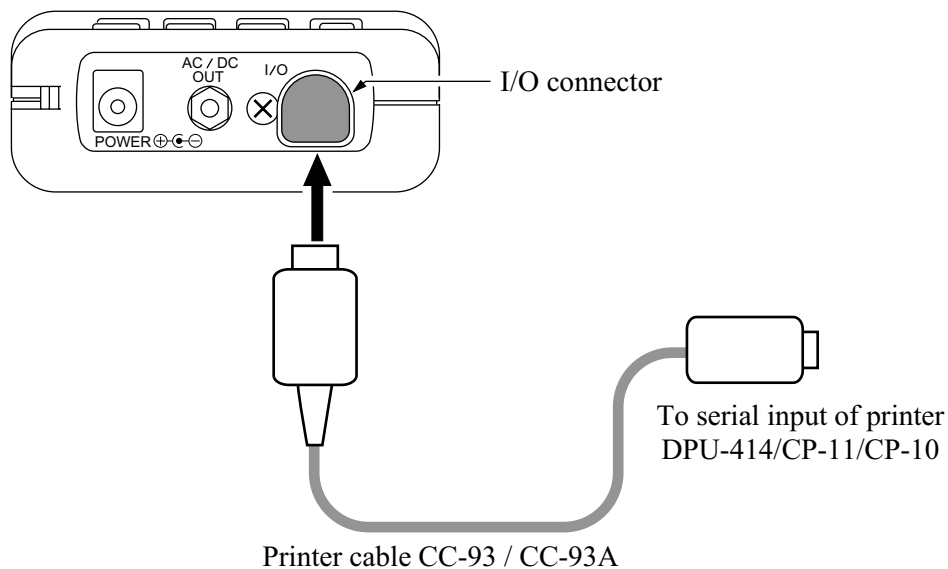

Use CC-93 for DPU-414.

Use CC-93A for CP-11 or CP-10.

Setting the software DIP switches of the DPU-414

Set the baud rate of the sound level meter to 19200 bps on menu screen 3/5. Turn on the power while holding down the ON LINE key of the DPU-414. A printout showing the current status of the printer is produced.

An example showing suitable software DIP switch settings for use of the printer with the NL-21/NL-31 is shown below. (The actual printout will be in a different font.)

```
Continue ?      :   Push' On-line SW'
Write ?        :   Push' Paper feed SW'
Dip SW-1
  1 (OFF)      :   Input = Serial
  2 (ON)       :   Printing Speed = High
  3 (ON)       :   Auto Loading = ON
  4 (OFF)      :   Auto LF = OFF
  5 (ON)       :   Setting Command = Enable
  6 (OFF)      :   Printing
  7 (ON)       :   Density
  8 (ON)       :   100 %
```

```
Continue ?      :   Push' On-line SW'
Write ?        :   Push' Paper feed SW'
Dip SW-2
  1 (OFF)      :   Printing Columns = 80
  2 (ON)       :   User Font Back-up = ON
  3 (ON)       :   Character Select = Normal
  4 (ON)       :   Zero = Normal
  5 (ON)       :   International
  6 (ON)       :   Character
  7 (ON)       :   Set
  8 (ON)       :   =Japan
```

```
Continue ?      :   Push' On-line SW'
Write ?        :   Push' Paper feed SW'
Dip SW-3
  1 (ON)       :   Data Length = 8 bits
  2 (ON)       :   Parity Setting = No
  3 (OFF)      :   Parity Condition = Even
  4 (OFF)      :   Busy Control = XON / XOFF
  5 (OFF)      :   Baud
  6 (ON)       :   Rate
  7 (ON)       :   Select
  8 (OFF)      :   = 19200 bps
Continue ?      :   Push'-line SW'
Write ?        :   Push' Paper feed SW'
```

DIP SW setting complete !!

For details, please refer to the documentation of the DPU-414.

Setting the software DIP switches of the CP-11/CP-10

Set the baud rate of the sound level meter to 9600 bps on menu screen 3/5.

Set the DIP switches of the printer as follows.

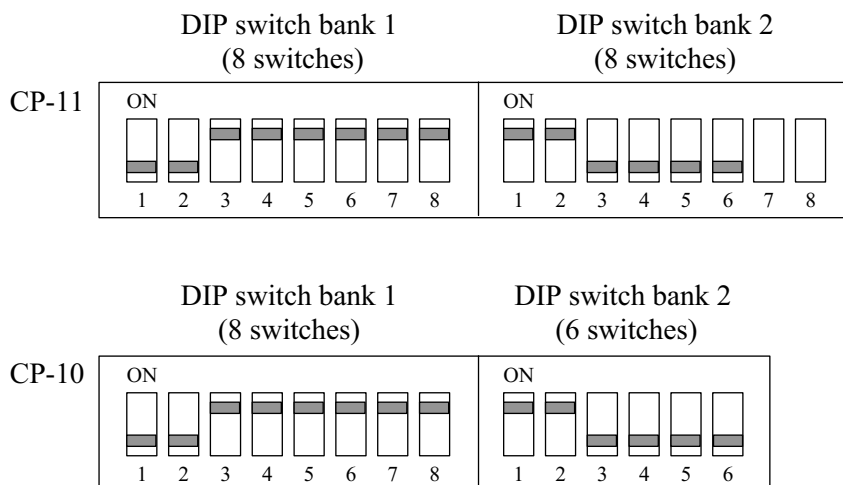

Important

Switches 7 and 8 of DIP switch bank 2 of printer CP-11 are set at the factory and should not be changed. Otherwise, correct printing may not be possible.

Connection to a Level Recorder (LR-06, LR-07, LR-04, LR-20A)

Sound level recording

Connect the AC/DC output on the bottom of the unit to the level recorder, as shown below.

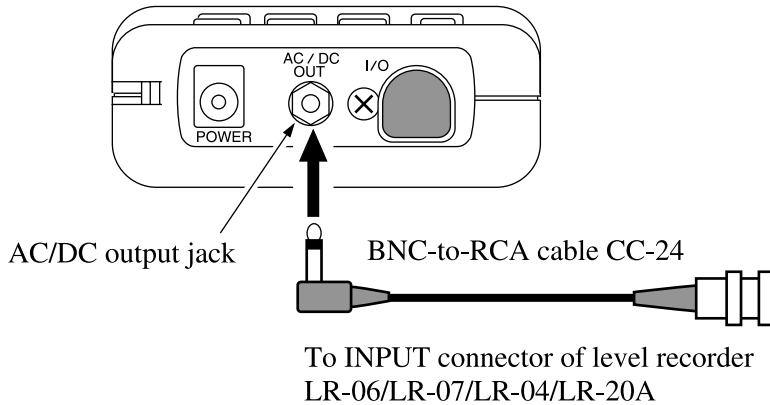

The AC/DC output is selected on the menu screen 3/5.

Connection to a Computer

Connect the I/O port on the bottom of the unit to the RS-232-C interface of the computer, using the optional Serial I/O cable.

For details, please refer to the Serial Interface Manual.

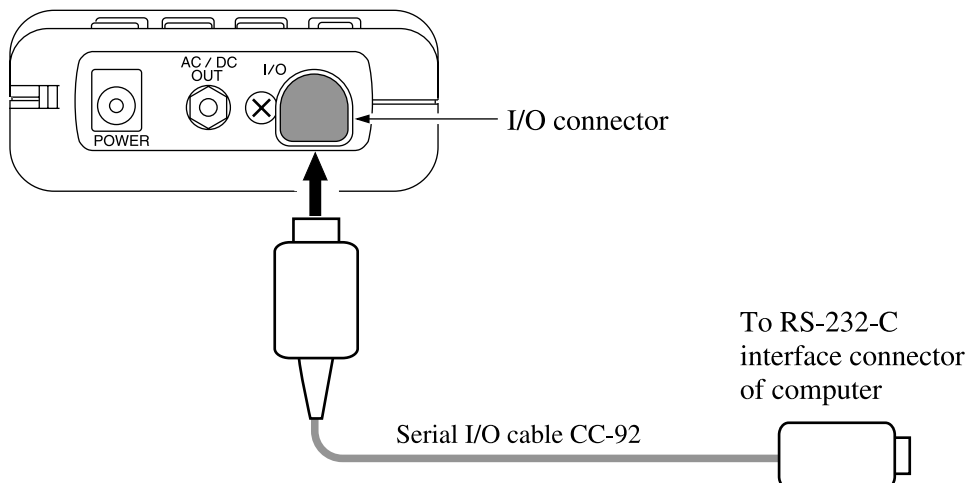

Setting the Date and Time

The unit incorporates a clock which allows recording the date and time along with measurement data on the memory card or on the unit itself.

Set the date and time as described below.

1. Turn the unit on by pressing the Power key.
2. Press the Menu key.

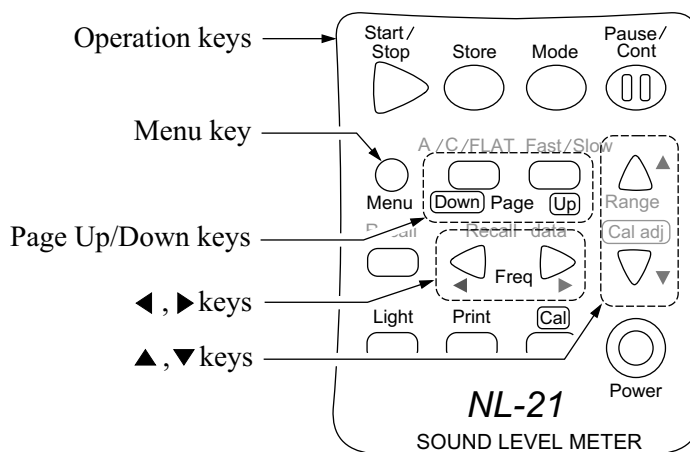

The display changes to the menu screen.

3. Use the Page Up/Down keys to bring up the indication 5/5 on the top right of the display.

When there is a card in the card slot

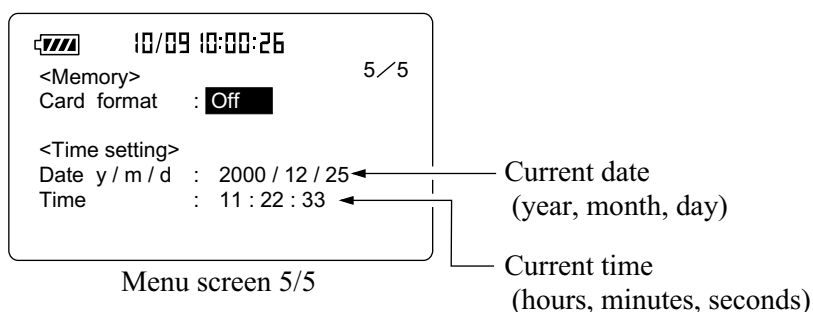

When there is no card in the card slot

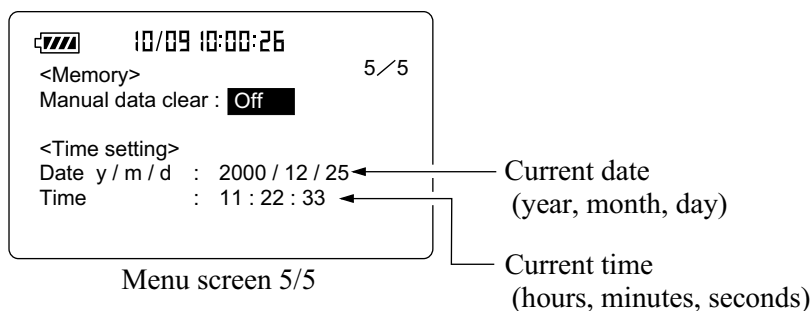

4. Use the ▲ and ▼ keys to move the highlight (field shown in reverse) to the item you want to set, and use the ◀ and ▶ keys to set the current date and time.
5. Press the Start key.
The internal clock begins to run with the selected settings.
6. Press the Menu key again to return to the measurement screen.

Note

The clock IC used in this unit has an error of about 1 minute per month. Before measurement, be sure to check and set the time if required.

An internal rechargeable backup battery keeps the clock of the unit running when the power is turned off. The backup battery is recharged by the main batteries. The clock will keep running for about 1.5 months on the backup battery alone. If the unit is not to be used for an extended period, the main batteries should be taken out to prevent possible damage due to battery fluid leakage. After reinserting the batteries, be sure to set the date and time.

Measurement in Dark Locations

Pressing the Light key turns the display backlight on, making it easier to read in dark locations. Pressing the key once more turns the light off.

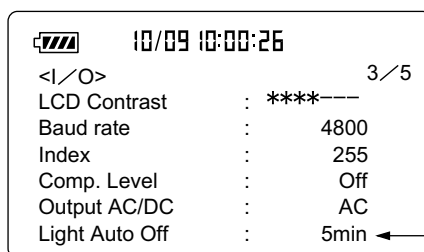
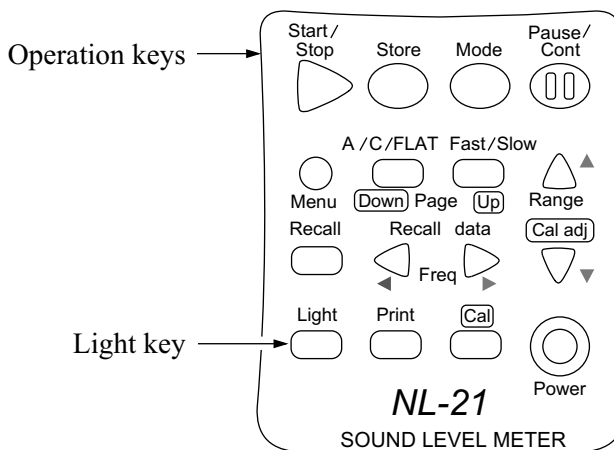

Light Auto Off
(Automatic backlight off)
5 min / Cont.

If the "Light Auto Off" item on the menu screen 3/5 is set to "5 min", the backlight turns itself off automatically after 5 minutes. When the item is set to "Cont.", backlighting is turned on and off with the Light key.

When the backlight is used continuously, battery life will be shortened to about half.

LCD Contrast

You can adjust the contrast of the display.

1. Press the Menu key.

The display changes to the menu screen.

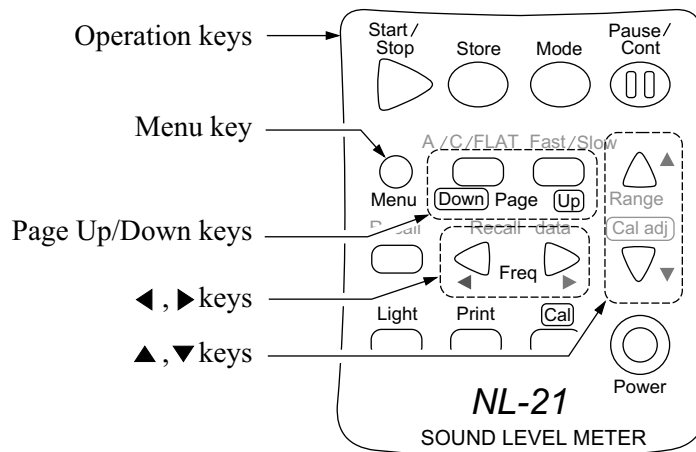

2. Use the Page Up/Down keys to switch to menu screen 3/5.

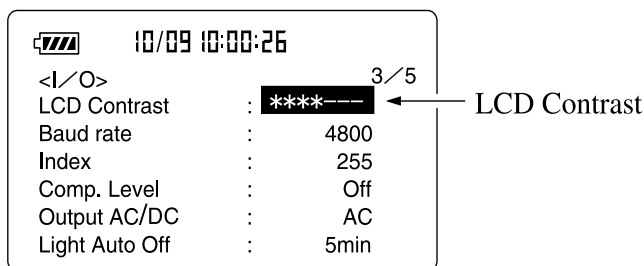

Menu screen 3/5

3. Use the ▼ key to move the cursor to the LCD Contrast * marks. (The item is shown in reverse.)
4. Increase or decrease number of * marks with ◀ and ▶ keys to adjust contrast
5. Press the Menu key again to return to the measurement screen.

Calibration

Before starting a measurement, the unit must be calibrated. There are two types of calibration: electrical calibration and acoustic calibration using a pistonphone.

Electrical calibration

The built-in oscillator (1 kHz, sine wave) is used for electrical calibration.

1. Turn the unit on by pressing the Power key.
2. Use the Level Range ▲ and ▼ keys to select the 30 to 120 dB range.
3. Press the Menu key to bring up the menu screen 1/5.

Verify that the Cal Mode is set to "Internal".

If "External" is shown, use the ▲ and ▼ keys to move the cursor to "External" and use the ◀ and ▶ keys to set it to "Internal".

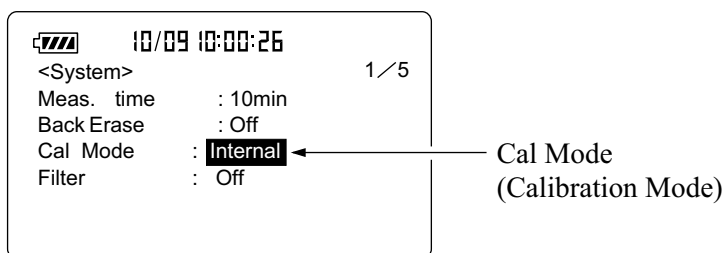

Menu screen 1/5

4. Press the Menu key again to return to the measurement screen.
5. Press the Cal key. The display becomes as shown below.
If the level range is not set to 30 to 120 dB, the indication flashes, and the required calibration value is 6 dB under the range maximum.

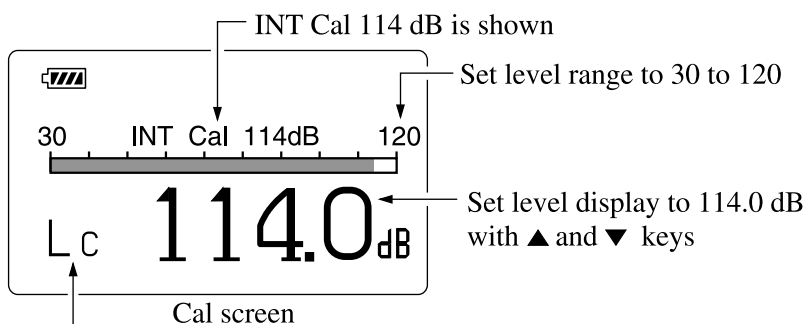

Frequency weighting automatically becomes L_C

6. Use the Cal adj ▲ and ▼ keys to set the level display to 114.0 dB. Frequency weighting is temporarily set to "C". When the Cal key is pressed again, the original settings are restored.

Signal output for calibration of external equipment

The normal level range for calibration is 30 to 120 dB, but in order to allow calibration of external equipment, calibration can also be performed at other level range settings. In this case, the "XX dB" indication of the calibration value flashes.

Perform the setting so that the calibration value is 6 dB under the maximum of the selected range.

In this case, the AC output or DC output is used to calibrate connected equipment.

1. Press the Menu key to bring up the menu screen 1/5.
Verify that the Cal Mode is set to "Internal".
2. Press the Menu key again to turn off the menu.
3. Press the Cal key.
4. Use the ▲ and ▼ keys to set the level indication to the calibration value (maximum -6 dB).
5. Press the Cal key again to return to normal measurement mode.

Note
Calibration cannot be performed if the unit is in a measurement mode other than sound level measurement (including triangle mark flashing in top left of screen, and pause). Perform calibration after measurement is completed (Start/Stop key was pressed).

Acoustic calibration with sound calibrator NC-74 or pistonphone NC-72

For acoustic calibration, the Rion sound calibrator NC-74 or pistonphone NC-72 is mounted to the microphone of the sound level meter, and adjustment is performed so that the reading of the meter is equal to the sound level inside the coupler.

Important

Be very careful when inserting and removing the microphone to and from the coupler, to avoid a sudden pressure buildup which could destroy the membrane of the microphone.

1. Turn off the sound calibrator or the pistonphone.
2. Turn on the NL-21/NL-31.
3. Press the Menu key to bring up the menu screen 1/5.
4. Verify that the Cal Mode is set to "External".

If "Internal" is shown, use the ▲ and ▼ keys to move the cursor to "Internal" and use the ◀ and ▶ keys to set it to "External".

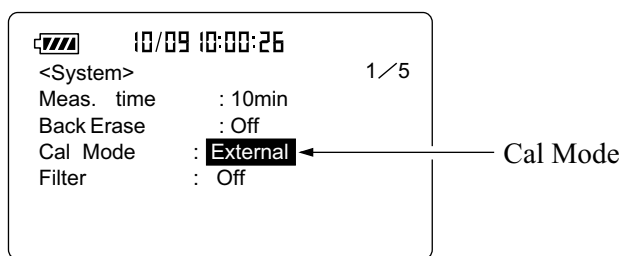
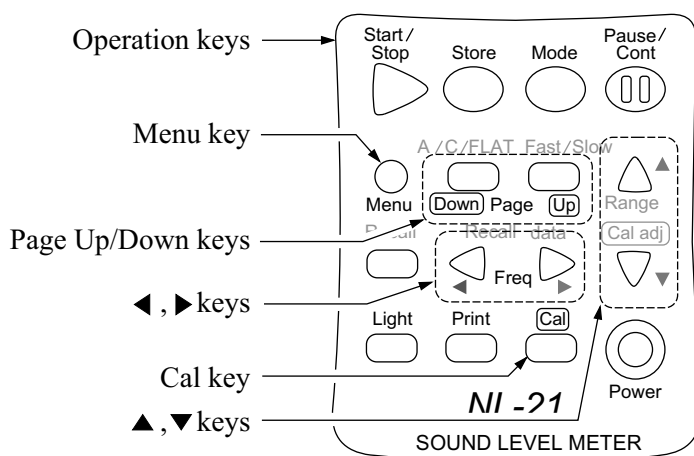

Menu screen 1/5

5. Press the Menu key again to return to the measurement screen.
6. Use the Level Range ▲ and ▼ keys to select the 30 to 120 dB range.

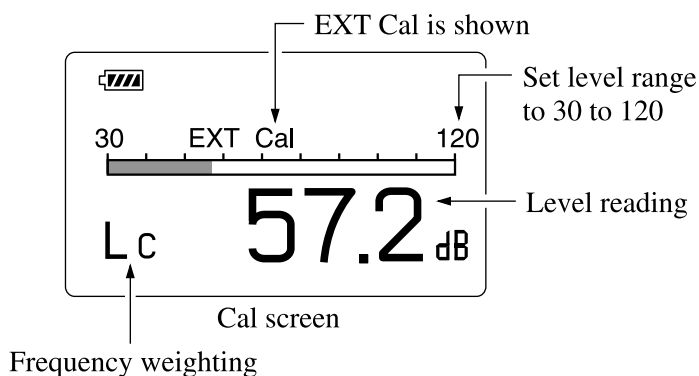

7. Press the Cal key. Frequency weighting is automatically set to "C". If the level range is not set to 30 to 120 dB, the EXT Cal indication flashes.
8. Mount the 1/2-inch adapter on the coupler of the sound calibrator or the pistonphone.

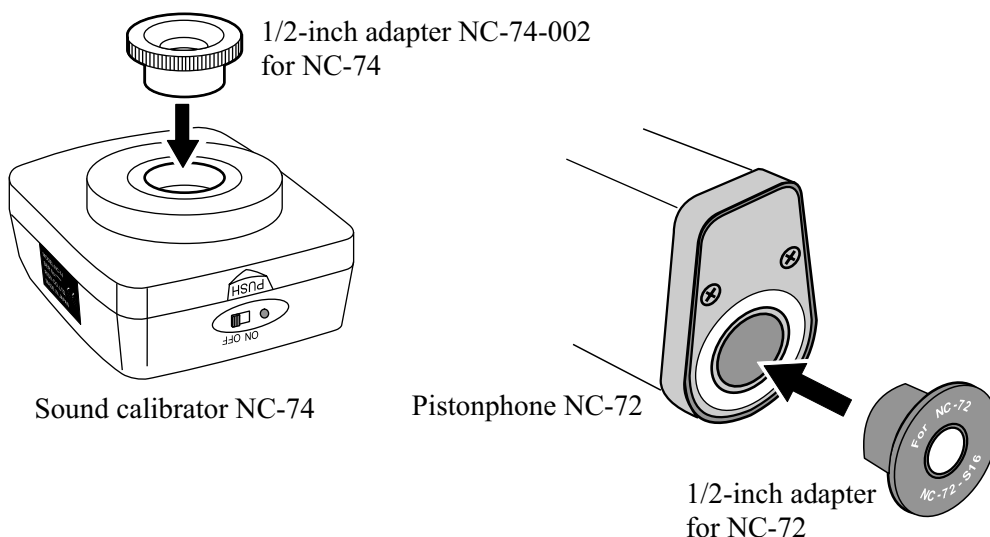

9. Insert the microphone very carefully and slowly all the way into the coupler.
10. Set the power switch of the sound calibrator or the pistonphone to ON.

11. Use the Cal Adj ▲ and ▼ keys to adjust the sound pressure reading of the NL-21/NL-31 according to the table below.

	NC-74	NC-72
NL-21	93.9 dB	Output sound pressure level imprinted on NC-72
NL-31	94.0 dB	

12. Turn off the sound calibrator or the pistonphone and NL-21/NL-31.
13. Remove the microphone very carefully and slowly from the coupler.

Note
For details on operation of the NC-74 or NC-72, please refer to the instruction manuals for them. For information about compensation for atmospheric pressure, please refer to the documentation of the pistonphone NC-72.
The NC-74 is designed to produce 94.0 dB under its rated conditions, but in actual calibration, the sound field compensation value which depends on the sound level meter must be taken into consideration. For the NL-21, adjust the reading to 93.9 dB. For the NL-31, use 94.0 dB.

Language selection

The language for the message on the screen can be selected. While holding the Mode key down, turn the unit on, select language screen is displayed. You can select the language among English, German or Spanish. After select the language, press Start/Stop key.

The selected language is memorized in the unit, the message is displayed in the selected language when power is turned on. As for the messages in each language, see page 136.

Reading the Display

Display screen

The illustration below is for demonstration purposes only. In actual use, not all display elements will be visible at the same time, and the size and font of the display may differ.

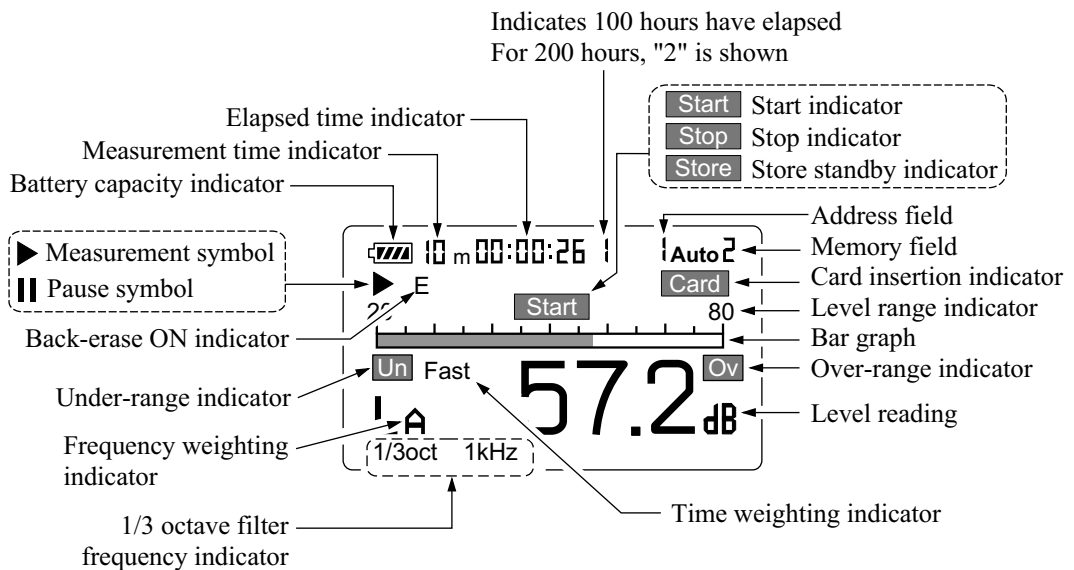

▶ Measurement symbol

Flashes while a measurement is in progress and while data are being stored in memory.

|| Pause symbol

Lights up when processing or storing is paused. In the paused condition, the sound level reading is not updated.

Battery capacity indicator

When operating the unit on batteries, periodically check this indicator to determine the remaining battery capacity. The number of black segments decreases as the batteries are used up. When the display starts to flash, correct measurement is no longer possible. Replace the batteries with a fresh set.

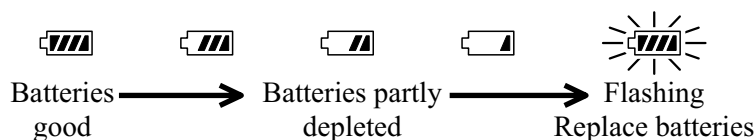

The indicator is also displayed while the unit is powered from the AC adapter.

Measurement time indicator

Shows the selected measurement time. If no measurement time was selected (arbitrary measurement time), the indication is blank.

The following measurement time settings are possible:

10 s (seconds), 1 m (minute), 5 m, 10 m, 15 m, 30 m, 1 h (hour), 8 h, 24 h, None

Elapsed time indicator

During processing and memory store, this indicator shows the elapsed time in seconds. If the time has exceeded 100 hours, the top digit of the address indicator shows "1".

Start indicator

This indicator appears for 1 second at measurement start.

Stop indicator

This indicator appears for 1 second at measurement stop.

Store standby indicator

Lights up when store to memory is carried out.

During manual operation, the indicator is active for 1 second. During auto operation, the indicator flashes together with the measurement symbol.

Memory field

Shows the selected memory store mode (Manu, Auto 1, or Auto 2).

Card insertion indicator

This indicator appears when a memory card is inserted.

Level range indicator

Shows the upper and lower limit of the bar graph. Make the setting that is appropriate for the sound level.

Bar graph

Shows the sound level. The indication is updated every 100 milliseconds.

Over-range indicator (shown as  for sound level)

Shown for at least 1 second when sound level overload has occurred.

Over-range indicator (shown as  for processed value)

Shown when any of the processed values contains an over-range level. Lights up when over-range occurs during processing and stays lit until the next processing measurement starts.

Level reading

Normally, this shows the sound level (updated every second).

Time weighting indicator

Shows the selected time weighting setting.

Filter frequency indicator

Shown when the 1/1 octave, 1/3 octave universal filter program has been installed.

Frequency weighting indicator

Shows the selected frequency weighting setting.

L_A : A

L_C : C

L_p : FLAT

The third and fourth digit are shown when processed values are displayed.

The meaning is as follows.

L_{Aeq} , L_{Ceq} , L_{peq} : Equivalent continuous sound level

L_{AE} , L_{CE} , L_{pE} : Sound exposure level

L_{Amax} , L_{Cmax} , L_{pmax} : Maximum time-weighted sound level

L_{Amin} , L_{Cmin} , L_{pmin} : Minimum time-weighted sound level

L_{A05} , L_{C05} , L_{p05} : 5% percentile sound level

L_{A10} , L_{C10} , L_{p10} : 10% percentile sound level

L_{A50} , L_{C50} , L_{p50} : 50% percentile sound level

L_{A90} , L_{C90} , L_{p90} : 90% percentile sound level

L_{A95} , L_{C95} , L_{p95} : 95% percentile sound level

Under-range indicator (shown as **Un** for sound level)

Shown when the sound level has fallen below -2.6 dB of the level range lower limit, or below the measurement range.

Under-range indicator (shown as **Un** for processed value)

Shown when any of the processed values contains an under-range level. Lights up when an under-range condition occurs during processing and stays lit until the next processing measurement starts.

Back-erase ON indicator

Lights up when the data back-erase function (page 77) is enabled.

Recall indicator

Lights up when data stored in memory are being displayed.

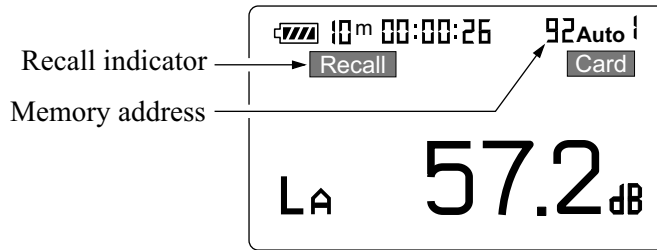

Recall screen

Measurement screen examples

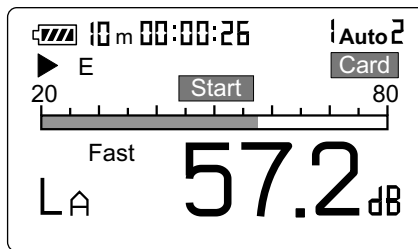

Sound level example

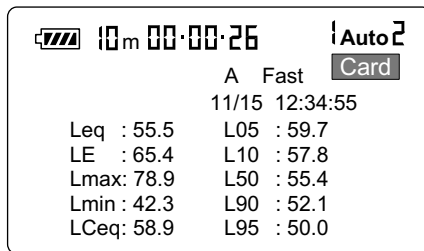

List display example

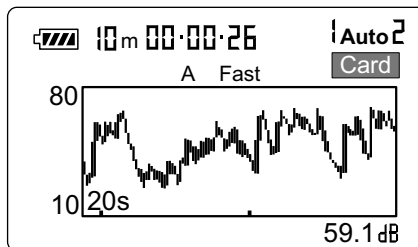

T-L (time level) display example

Menu screens

There are five menu screens numbered 1/5 through 5/5.

Menu screen 1/5

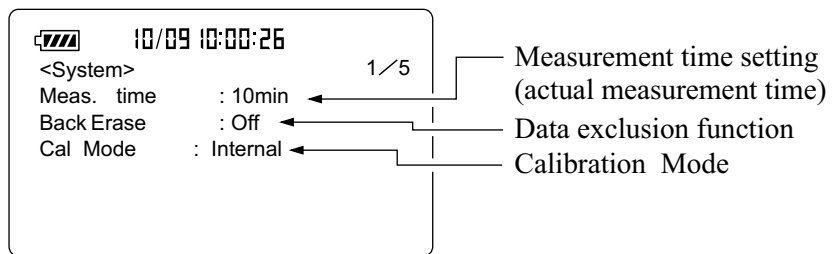

Menu screen 1/5

Meas. time (measurement time)

Use ◀, ▶ keys to select the measurement time.

Manual → 10 sec → 1 min → 5 min → 10 min → 15 min → 30 min →
1 hour → 8 hours → 24 hours → Manual → ...

When set to Manual, the maximum measurement time is 200 hours.

Back Erase (data exclusion function)

This function allows excluding the last 5 seconds before activation of the pause condition from processing.

Off: Normal pause function

5 sec: 5 seconds preceding pause are excluded

Cal mode (calibration mode)

Internal: Select this position for electrical calibration of the unit using the built-in oscillator.

External: Select this position for acoustic calibration of the unit using a pistonphone.

When optional filter program is installed

Filter On/Off

When set filter to On, one of the following indications appears, depending on the installed filter type.

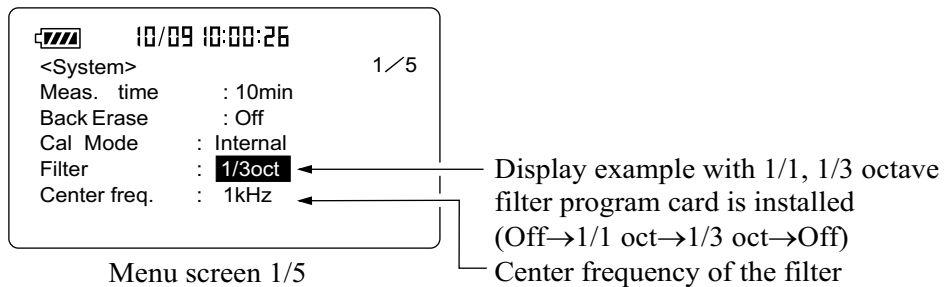
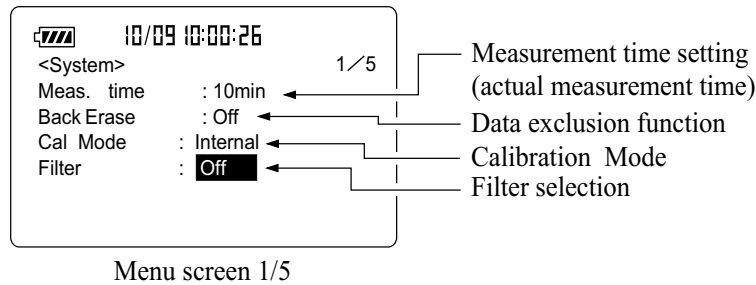

Center frequency of the filter can be changed with ◀ and ▶ keys on the measurement screen.

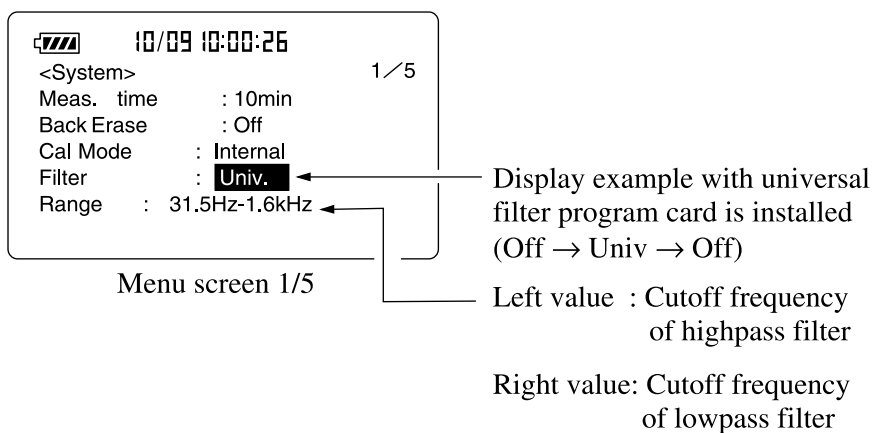

Cutoff frequency of the high-pass filter can be changed with ◀ key on the measurement screen.

Cutoff frequency of the low-pass filter can be changed with ▶ key on the measurement screen.

Important
<p>Auxiliary processing function does not work when set the 1/1 or 1/3 octave filter and universal filter to On.</p> <p>Set the auxiliary processing values to "Off" on Display of the menu screen (4/5) (see page 41). If the setting is "On", the wrong value is displayed.</p>

Menu screen 2/5

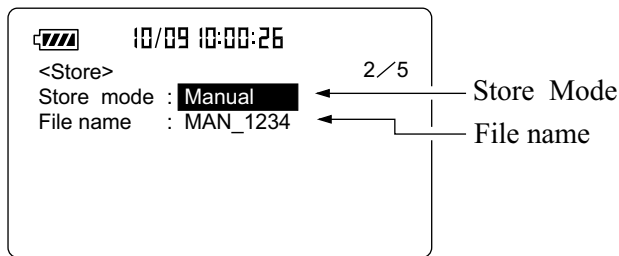

Menu screen 2/5

Store Mode

- Manual:** Up to 100 data sets (sound level, store time, processing/auxiliary processing values, processing start time) can be stored.
- When storing on a memory card, the maximum is 100 data sets per file.
- Auto 1 (L_p):** Sound level for 100 ms, 200 ms, or 1 s, or $L_{Aeq,1 \text{ sec}}$ is stored continuously on the memory card.
- Auto 2 (L_{eq}):** Sound level data and main and auxiliary processing values are stored on the memory card at the preset measurement time interval.
- Timer Auto 1:** Auto 1 store is performed with the timer function.
- Timer Auto 2:** Auto 2 store is performed with the timer function.

File name

Determines the file name for storing (4-digit number).

- Auto1 Samp.:** Sampling interval for Auto1 store. Displayed as required.
- 100 msec → 200 msec → 1 sec → $L_{eq,1 \text{ sec}}$ →
- Start:** Measurement start time. Displayed as required.
- Stop:** Measurement stop time. Displayed as required.
- Interval:** Measurement cycle. Displayed as required.
- Off → 5 min → 10 min → 15 min → 30 min → 1 hour → Off ...

Menu screen 3/5

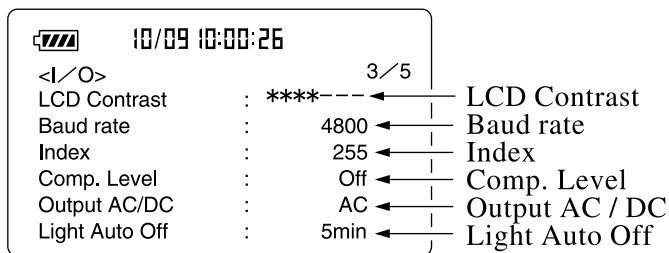

Menu screen 3/5

LCD Contrast

The number of * symbols corresponds to the contrast setting. It can be changed with the ◀ and ▶ keys.

Baud rate (I/O transfer speed)

You can select 4800 bps, 9600 bps or 19200 bps with the ◀ and ▶ keys. This speed setting applies to serial communication with the RS-232-C interface of a PC and to data output to a printer.

Index

This is a number identifying the unit when multiple units (up to 255) are used. The setting range is 1 to 255.

Comp. Level

When a level exceeding this value is measured, a signal is output from the I/O connector. This is an open-collector output that is active for at least 1 second when the sound level exceeds the setting level.

Setting level is Off → 30 dB to 130 dB (1-dB step) → Off

Output AC/DC

Selects whether an AC or DC signal is output from the I/O connector.

Light Auto Off

Controls the automatic backlight turn-off function. When set to "Cont.", backlight on/off is controlled only by the Light key and is not automatically turned off.

Menu screen 4/5

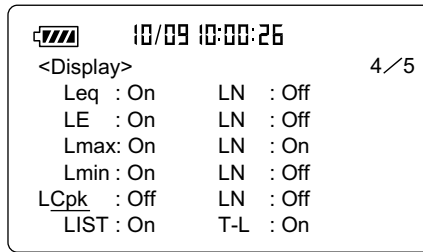

Menu screen 4/5

Leq: Equivalent continuous sound level
 LE: Sound exposure level
 Lmax: Maximum time-weighted sound level
 Lmin: Minimum time-weighted sound level
 LCpk: Auxiliary processing value
 LIST: List display
 LN: Percentile sound level
 T-L: Time/Level

Leq (Equivalent continuous sound level)

Set to "On" if the processing result is to be displayed, otherwise set to "Off".

LE (Sound exposure level)

Set to "On" if the processing result is to be displayed, otherwise set to "Off".

Lmax (Maximum sound level), Lmin (Minimum sound level)

Set to "On" if the processing result is to be displayed, otherwise set to "Off".

Lxxx (Auxiliary processing values, Lpeak, LCpeak, LCEq, LAtm5, LAI, LAleq)

Auxiliary processing value can be chosen on this screen.

L_{peak} :	Peak sound level
L_{Cpeak} :	C-weighted peak sound level
L_{CEq} :	C-weighted equivalent continuous sound level
L_{Atm5} :	Power average of maximum sound level in a given interval (5 seconds)
L_{AI} :	Impulse sound level
L_{AIeq} :	Impulse equivalent continuous sound level

Note

L_{Atm5} , L_{AI} , and L_{A1eq} can only be chosen when A weighting is selected for main processing. If C weighting is selected, the L_{Ceq} auxiliary processing function does not operate.

When not using the auxiliary processing functions, set the display of auxiliary processing values to Off. In the On condition, battery life will be about 20 percent shorter.

LIST (List display)

Set to "On" if the processing result is to be displayed, otherwise set to "Off".

LN (Percentile sound level)

Can be set from L01 to L99.

Set to "On" if the processing result is to be displayed, otherwise set to "Off".

T-L (Time/Level)

Set to "On" if the processing result is to be displayed, otherwise set to "Off".

Note

For processing functions other than auxiliary processing, the measurement is carried out also when the function is set to "Off". An auxiliary processing function is only carried out when set to "On".

When auxiliary processing is set to "On", battery life will be shorter by about 20 percent.

Menu screen 5/5

When there is a card in the card slot

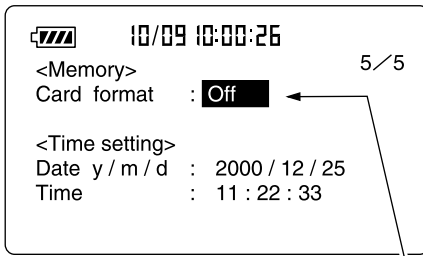

Menu screen 5/5

Card Format On/Off

When there is no card in the card slot

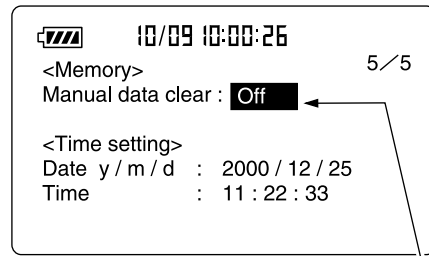

Menu screen 5/5

Manual data clear On/Off

Card Format On/Off

This item is shown when there is a card in the card slot.

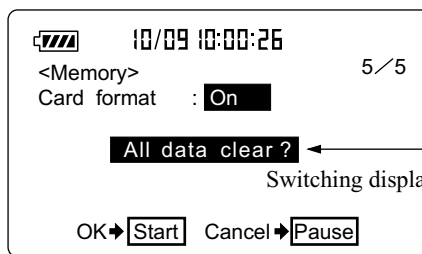

Menu screen 5/5

Shown when "Card Format "
is set to "On"

All data clear ?
Switching display every 0.5 second

When "On" is selected, the indications "All data clear?" and "OK → Start
Cancel → Pause" are displayed.

Pressing "Start" key allows deleting all data on a memory card.

Manual data clear On/Off

This item is shown when there is no card in the card slot.

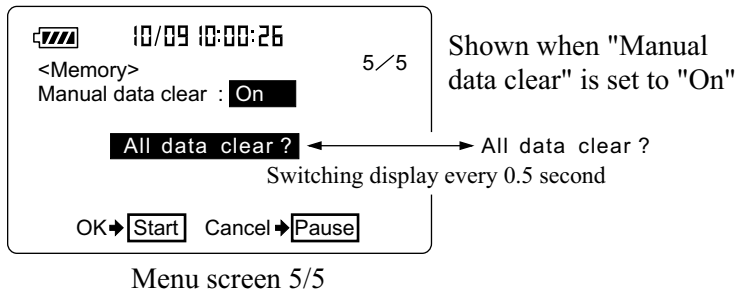

When "On" is selected, the indications "All data clear?" and "OK → Cancel → " are displayed.

Pressing "Start" key allows deleting all data in the internal memory.

Date y/m/d

Year/month/day

Time

Hours/minutes/seconds

When you select one of the items year, month, day, hours, minutes, seconds, the indication "Set ready? → " flashes. Pressing the Start key in this condition allows you to set the internal clock. The clock then starts running from the new time.

Power On/Off

Power-on

Turn the unit on by holding down the Power key for at least one second. When the power-on screen appears, release the Power key. After the initial screen was shown, the unit switches to the measurement screen.

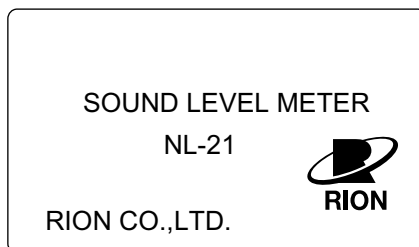
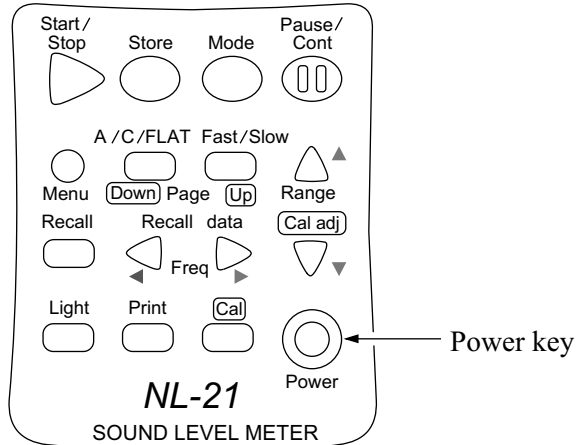

Power-on screen

Power-off

Turn the unit off by holding down the Power key for at least one second.
When the power-off screen appears, release the Power key.



Power-off screen

Note
Wait at least 5 seconds after turning the unit off before you turn it on again.

Measurement

When using this unit in a mode other than sound level measurement, all processing functions provided by the unit are carried out simultaneously. (However, only the auxiliary processing function set to "On" on the Menu screen 4/5 "Display" screen is carried out.) For example, when equivalent continuous sound level measurement is selected, the sound exposure level and percentile level are also determined. However, the time percentage setting for the percentile level (5 values) must be selected beforehand. Also, make sure that the date and time are set correctly, as described on page 21.

Sound level Measurement

The procedure for sound level measurement is described below.

Preparations as described in the previous chapter must be completed first.

Sound level

1. Turn the unit on by pressing the Power key.

After the power-on screen, the measurement screen is shown.

The various settings depend on the condition the unit was in before it was last turned off.

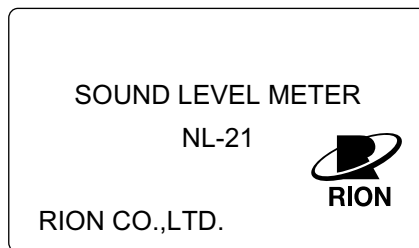

Power-on screen

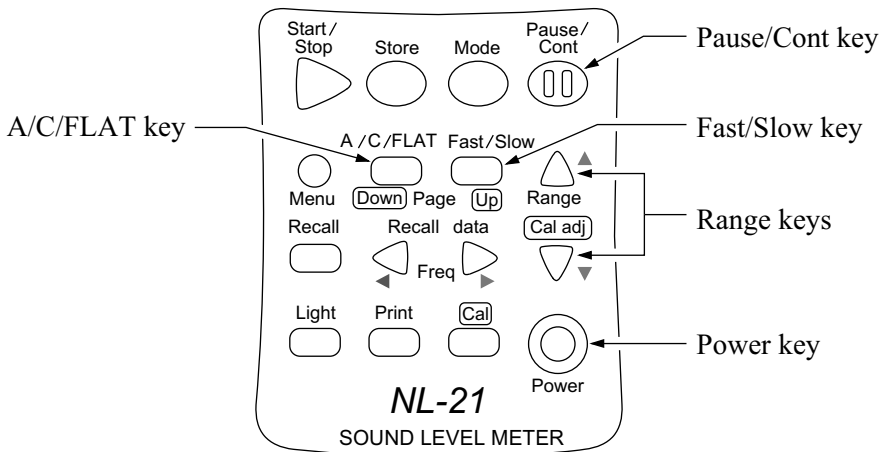

2. Select the frequency weighting with the A/C/FLAT key. For normal sound level measurements, select the "A" setting.
 If " L_p " (Flat) is selected, the sound level from 20 Hz to 12.5 kHz for NL-31 and from 20 Hz to 8 kHz for NL-21 can be measured.
 When L_C is selected for display, the sound level from 31.5 Hz to 8 kHz is measured with flat characteristics.
3. Use the Fast/Slow key to select the time weighting (dynamic characteristics). Normally, the "Fast" setting should be used.
4. When performing measurements according to JIS or other standards, the frequency weighting and time weighting setting required by the standard should be selected.
5. Use the Level Range keys to select the level range. Choose a setting in which the bar graph indication registers to about the middle of the range.
 If the "Ov" (Over) or "Un" (Under) indicators light up frequently, change the level range setting.

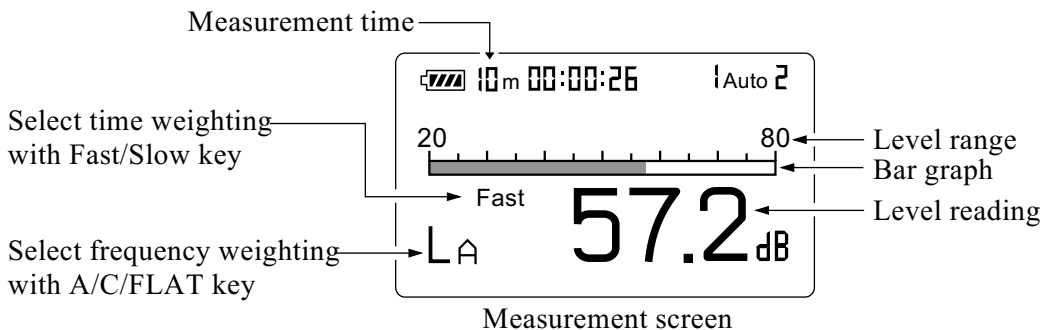

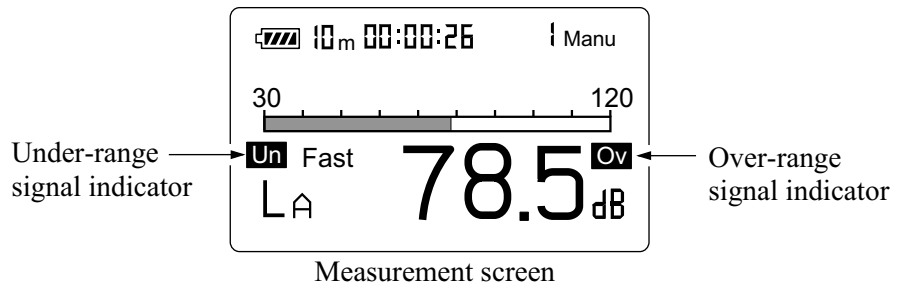

6. The numeric level indication shows the currently measured sound level. The reading is updated once every second. The Pause/Cont key can be used to stop and start the level reading from being updated. The bar graph indication is updated during pause condition. In the pause condition, a **||** mark appears on the display. Pressing the Pause/Cont key once more resumes the measurement.

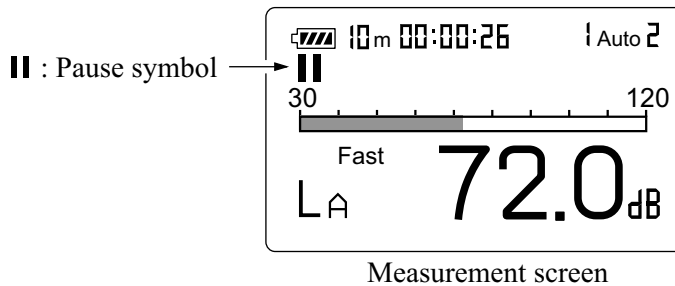

Important

During sound level measurement, do not press the Mode key because this causes the processing results to be displayed. As shown in the example, if the letter following "L" is displayed without an appendix, sound level measurement is being carried out.

L_A Display shows sound level.

L_{Aeq} Display does not show sound level.

Equivalent Continuous Sound level (L_{Aeq}) Measurement

The procedure for equivalent continuous sound level measurement is described below.

Preparations as described in the previous chapter must be completed first.

1. Turn the unit on by pressing the Power key.
2. Select the frequency weighting with the A/C/FLAT key. For normal measurements, select the "A" setting.
When "C" (C weighting) is selected, the equivalent continuous sound level (L_{Ceq}) is measured.
3. Use the Fast/Slow key to select the time weighting. Normally, the "Fast" setting should be used.

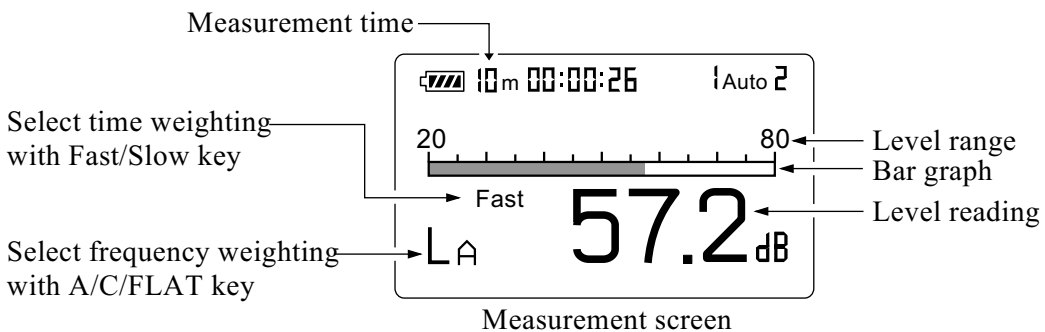

4. Use the Level Range keys to select the level range. Choose a setting in which the bar graph indication registers to about the middle of the range.

If the "Ov" (Over) or "Un" (Under) indicators light up frequently, change the level range setting.

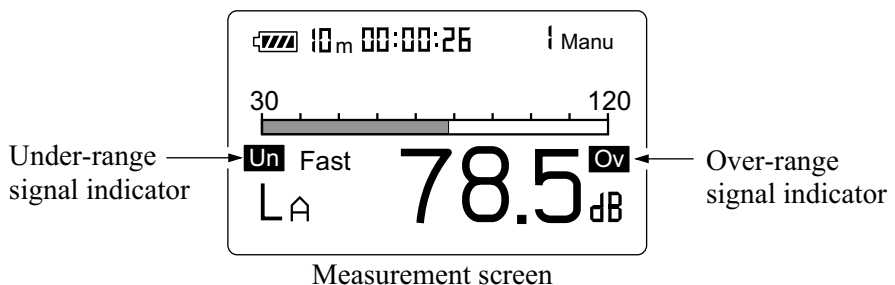

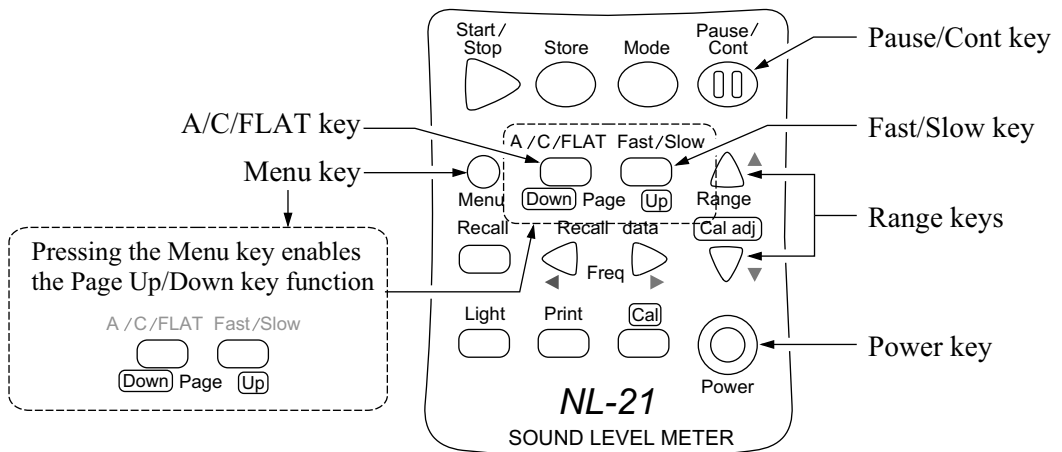

Note

This unit uses high-speed sampling of the sound pressure waveform for L_{eq} and L_E processing (NL-21: 30.3 μ s, NL-31: 20.8 μ s). The result is therefore unaffected by dynamic characteristics and accurate also for a short time period.

The auxiliary processing function for equivalent impulse sound level is affected by the dynamic characteristics.

- Use the menu to set the measurement time.
Press the Menu key to call up the menu screen 1/5.

6. Use the ▲ and ▼ keys to move the cursor to the "Meas. time" item, and use the ◀ and ▶ keys to select the measurement time.

Manual → 10 sec → 1 min → 5 min → 10 min → 15 min → 30 min
→ 1 hour → 8 hours → 24 hours → Manual → ...

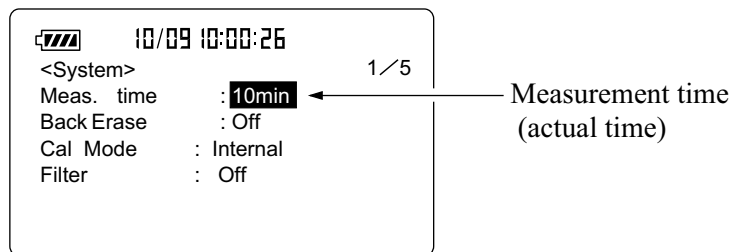

Menu screen 1/5

7. Use the Page Up/Down keys to display the menu screen 4/5.
If L_{eq} : Off is displayed, use the ▲ and ▼ keys to move the highlight to "Off", and use the ◀ and ▶ keys to set the item to "On".

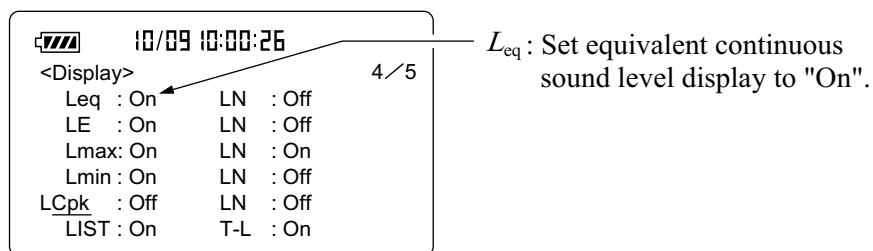

Menu screen 4/5

8. To use the data exclusion (back-erase) function, please refer to page 77.

Note

In addition to the regular pause function it is also possible to exclude (back-erase) data from the immediately preceding 5 seconds.

9. Press the Menu key to return to the measurement screen.

10. Press the Start/Stop key to start the measurement.

During measurement, the ► symbol flashes and the elapsed measurement time is displayed.

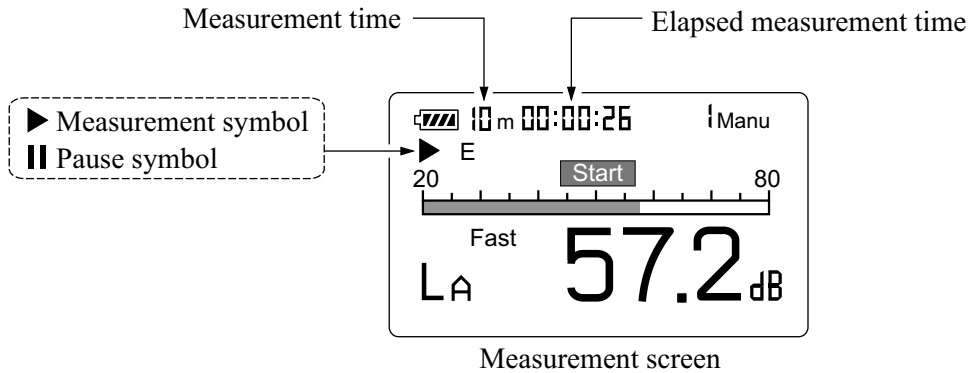

When the measurement time set in step 6 has elapsed, the measurement terminates automatically. When wishing to terminate the measurement earlier, press the Start/Stop key.

If Manual was selected, the Start/Stop key must be used to conclude the measurement.

If an under-range condition or over-range condition occurs at least once during measurement, the "[Ov]" (Over) or "[Un]" (Under) indicator appears, to show that the processing data contain over-range or under-range data.

Important

During measurement, most of the keys such as the A/C/FLAT key and Level keys are inoperative. Only the following four keys can be used: Start/Stop, Pause/Cont, Mode, Light. All other settings must be made before starting the measurement.

During measurement, the Pause/Cont key can be used to pause and resume the measurement. During pause, the pause symbol (||) is shown. (Any pause intervals and the back-erase time if data back-erase is enabled are not included in the measurement time.)

If data back-erase was enabled in step 8, the data are indicated on the display, as shown on next page.

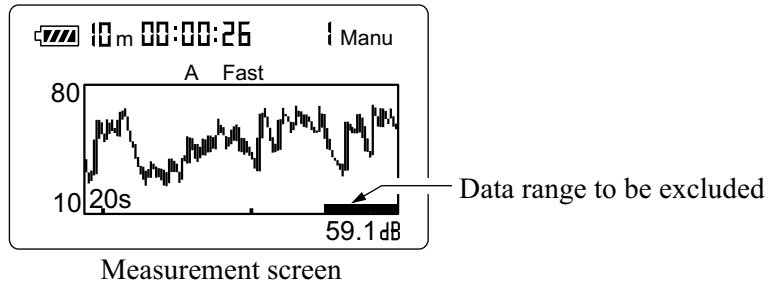

11. When the measurement is completed, you can use the Mode key to switch between various ways of displaying the measurement result. When L_{Aeq} is shown, the equivalent continuous sound level is being displayed.

If L_{Aeq} is not shown, check whether L_{eq} on the "Display" menu screen 4/5 is set to "On".

If "Ov" (Over) is shown, the sound level data used for processing contained over-range data.

If "Un" (Under) is shown, the sound level data used for processing contained under-range data.

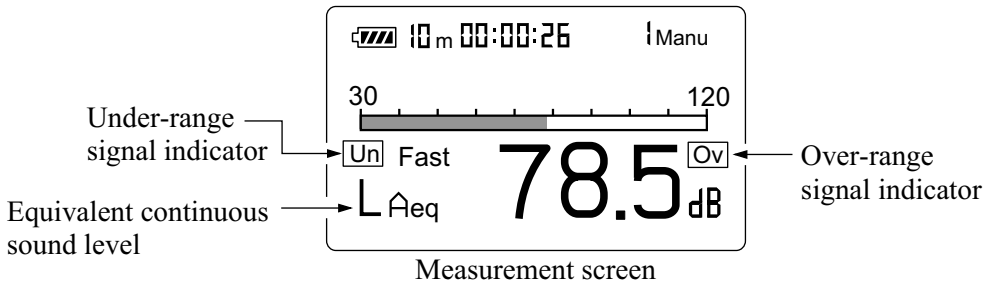

Note
It is also possible to use the Mode key during measurement to read the equivalent continuous sound level up to that point. (This applies only to the numeric level display. The bar graph indication shows the sound level.)
Changing the A/C/FLAT or Fast/Slow setting after measurement is completed has no effect on the displayed processing result.

Sound Exposure Level (L_{AE}) Measurement

The procedure for sound exposure level measurement is described below. It is very similar to the measurement of equivalent continuous sound level. Preparations as described in the previous chapter must be completed first.

1. Turn the unit on by pressing the Power key.
2. Select the frequency weighting with the A/C/FLAT key. For normal measurements, select the "A" setting.
3. Use the Fast/Slow key to select the time weighting. Normally, the "Fast" setting should be used.

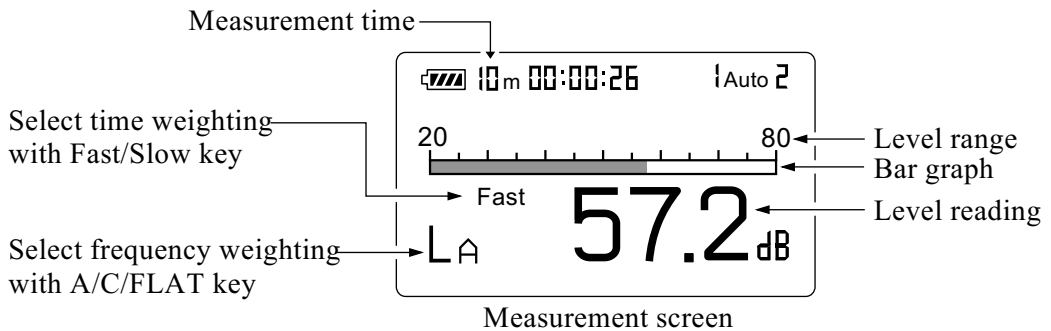

4. Use the Level Range keys to select the level range. Choose a setting in which the bar graph indication registers to about the middle of the range.
If the "Ov" (Over) or "Un" (Under) indicators light up frequently, change the level range setting.

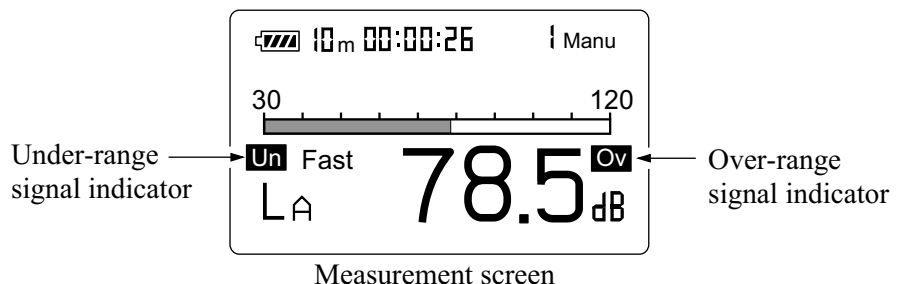

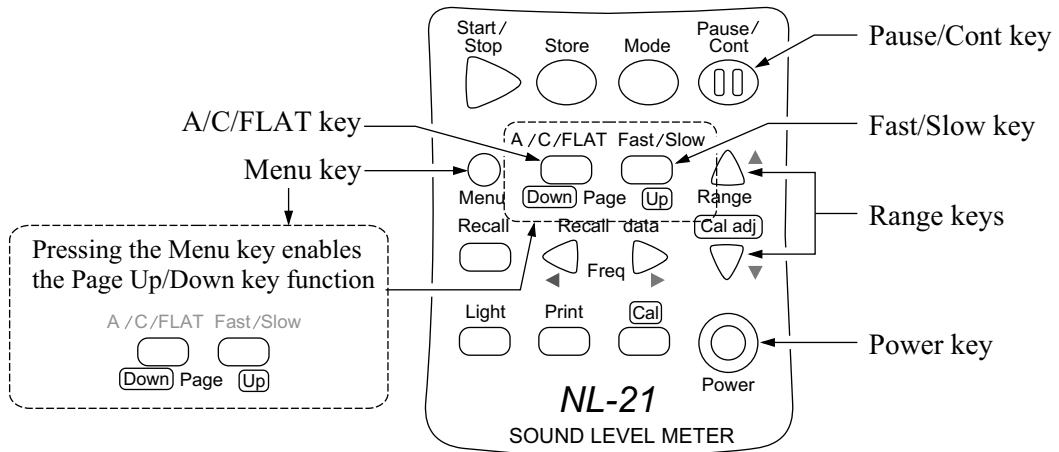

Note

This unit uses high-speed sampling of the sound pressure waveform for L_{eq} and L_E processing (NL-21: 30.3 μ s, NL-31: 20.8 μ s). The result is therefore unaffected by dynamic characteristics and accurate also for a short time period.

5. Use the menu to set the measurement time.
Press the Menu key to call up the menu screen 1/5.
6. Use the ▲ and ▼ keys to move the cursor to the "Meas. time" item, and use the ◀ and ▶ keys to select the measurement time.

Manual → 10 sec → 1 min → 5 min → 10 min → 15 min → 30 min → 1 hour → 8 hours → 24 hours → Manual → ...

When Manual is selected, the measurement time is controlled by the operator. The maximum time is 200 hours.

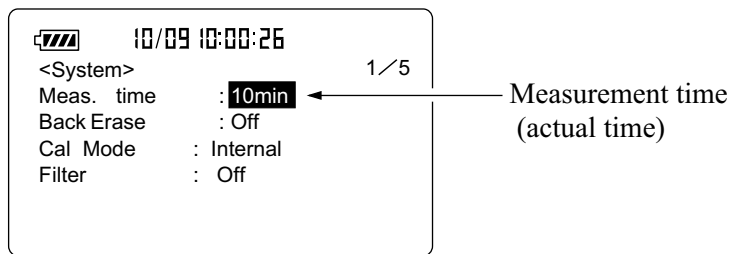

Menu screen 1/5

7. Use the Page Up/Down keys to display the menu screen 4/5.
If L_E : Off is displayed, use the ▲ and ▼ keys to move the highlight to "Off", and use the ◀ and ▶ keys to set the item to "On".

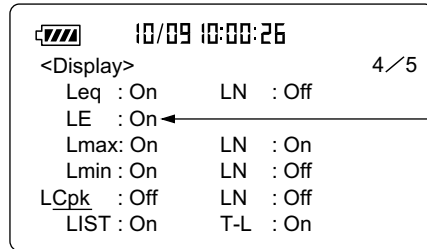

L_E : Set sound exposure level display to "On".

Menu screen 4/5

8. To use the data exclusion (back-erase) function, please refer to page 77.

Note

In addition to the regular pause function it is also possible to exclude (back-erase) data from the immediately preceding 5 seconds.

9. Press the Menu key to return to the measurement screen.
10. Press the Start/Stop key to start the measurement.
During measurement, the ▶ symbol flashes and the elapsed measurement time is displayed.

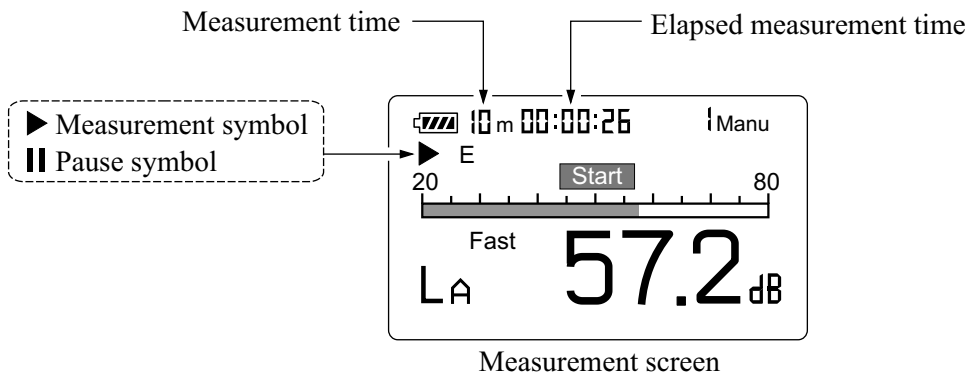

When the measurement time set in step 6 has elapsed, the measurement terminates automatically. When wishing to terminate the measurement earlier, press the Start/Stop key.

If no display (arbitrary measurement time) was selected, the Start/Stop key must be used to conclude the measurement.

If an under-range condition or over-range condition occurs at least once during measurement, the "Ov" (Over) or "Un" (Under) indicator appears, to show that the processing data contain over-range or under-range data.

Important

During measurement, most of the keys such as the A/C/FLAT key and Level keys are inoperative. Only the following four keys can be used: Start/Stop, Pause/Cont, Mode, Light. All other settings must be made before starting the measurement.

During measurement, the Pause/Cont key can be used to pause and resume the measurement. During pause, the pause symbol (||) is shown. (Any pause intervals and the back-erase time if data back-erase is enabled are not included in the measurement time.)

If data back-erase was enabled in step 8, the data are indicated on the display, as shown below.

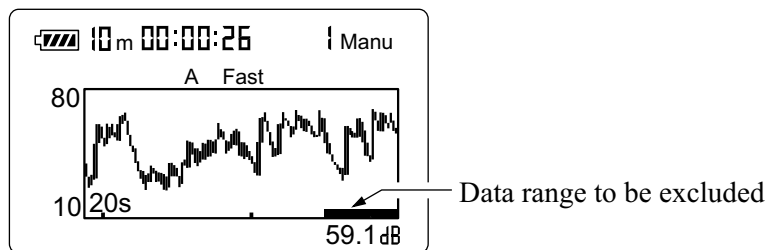

Measurement screen

11. When the measurement is completed, you can use the Mode key to switch between various ways of displaying the measurement result. When L_{AE} is shown, the sound exposure level is being displayed. If L_{AE} is not shown, check whether L_{AE} on the "Display" menu screen is set to "On".
- If "Ov" (Over) is shown, the sound level data used for processing contained over-range data.
- If "Un" (Under) is shown, the sound level data used for processing contained under-range data.

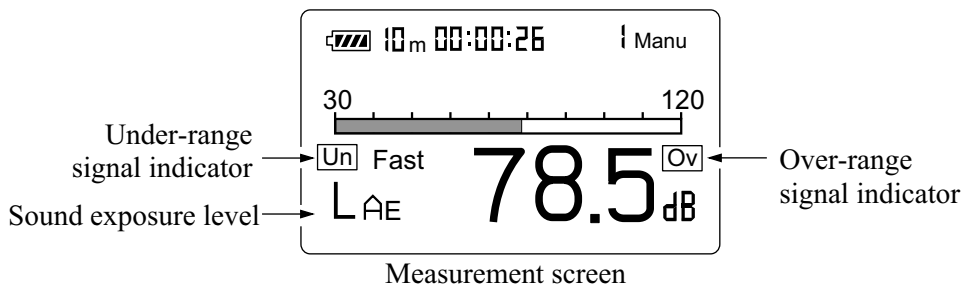

Note

It is also possible to use the Mode key during measurement to read the equivalent continuous sound level up to that point. (This applies only to the numeric level display. The bar graph indication shows the sound level.)

Changing the A/C/FLAT or Fast/Slow setting after measurement is completed has no effect on the displayed processing result.

Maximum (L_{max}) and Minimum (L_{min}) Sound level Measurement

The procedure for maximum and minimum sound level measurement is described below.

Preparations as described in the previous chapter must be completed first.

1. Turn the unit on by pressing the Power key.
2. Select the frequency weighting with the A/C/FLAT key. For normal measurements, select the "A" setting.
3. Use the Fast/Slow key to select the time weighting. Normally, the "Fast" setting should be used.

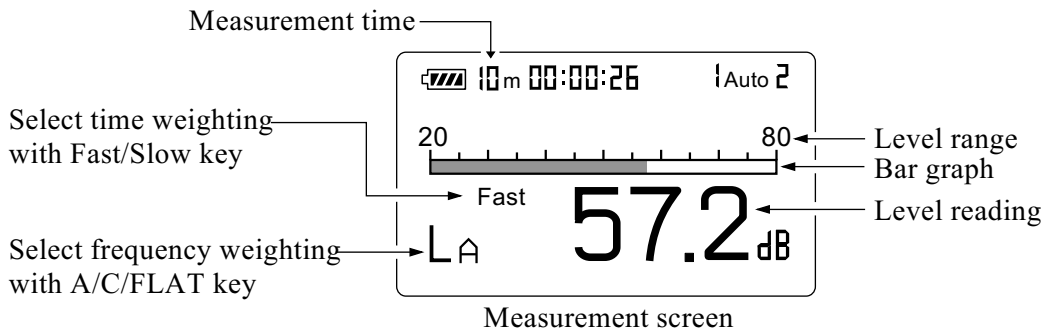

4. Use the Level Range keys to select the level range. Choose a setting in which the bar graph indication registers to about the middle of the range.

If the "Ov" (Over) or "Un" (Under) indicators light up frequently, change the level range setting.

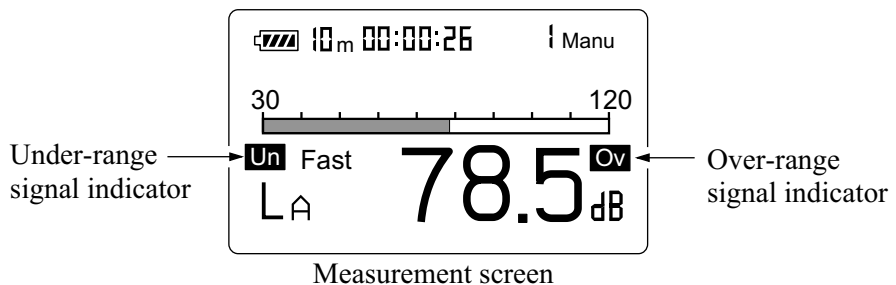

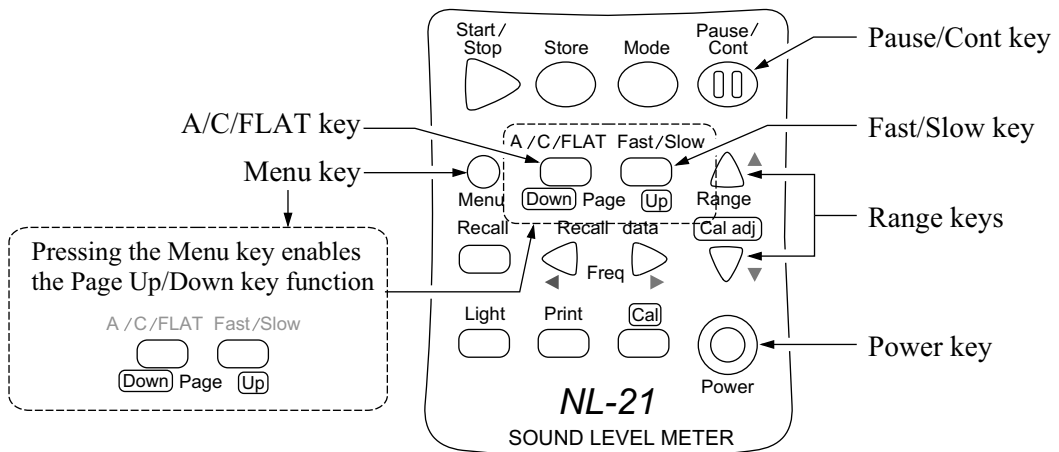

- Use the menu to set the measurement time.
Press the Menu key to call up the menu screen 1/5.
- Use the ▲ and ▼ keys to move the cursor to the "Meas. time" item, and use the ◀ and ▶ keys to select the measurement time.

Manual → 10 sec → 1 min → 5 min → 10 min → 15 min → 30 min → 1 hour → 8 hours → 24 hours → Manual → ...

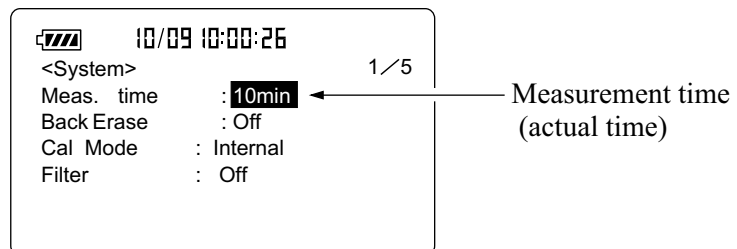

Menu screen 1/5

- Use the Page Up/Down keys to display the menu screen 4/5.
If L_{\max} : Off, L_{\min} : Off is displayed, use the ▲ and ▼ keys to move the highlight to "Off", and use the ◀ and ▶ keys to set the item to "On".

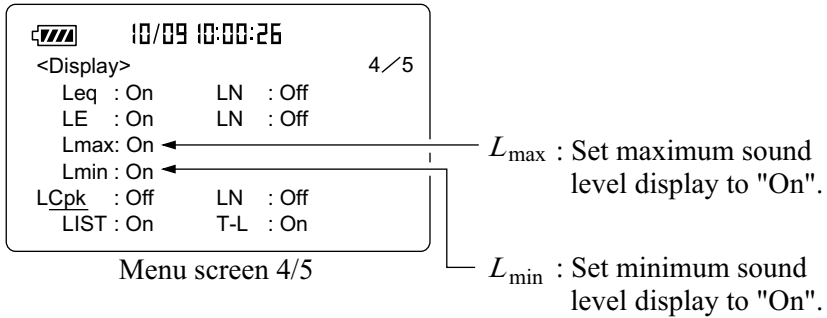

8. To use the data exclusion (back-erase) function, please refer to page 77.

Note

In addition to the regular pause function it is also possible to exclude (back-erase) data from the immediately preceding 5 seconds.

9. Press the Menu key to return to the measurement screen.

10. Press the Start/Stop key to start the measurement.

During measurement, the ► symbol flashes and the elapsed measurement time is displayed.

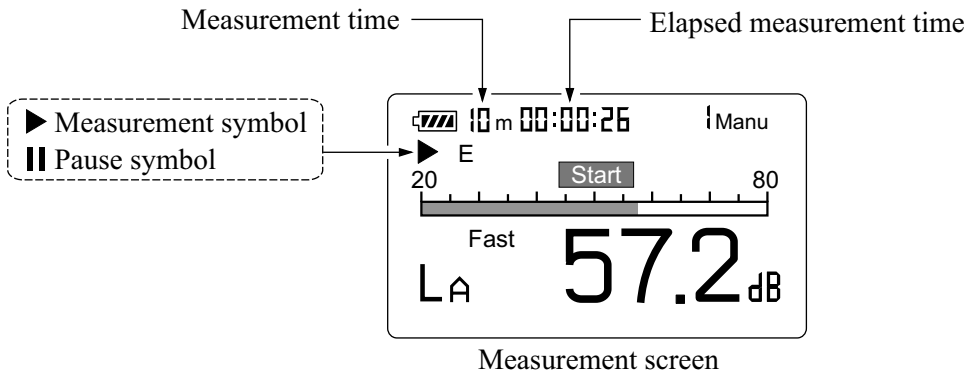

When the measurement time set in step 6 has elapsed, the measurement terminates automatically. When wishing to terminate the measurement earlier, press the Start/Stop key.

If no display (arbitrary measurement time) was selected, the Start/Stop key must be used to conclude the measurement.

If an under-range condition or over-range condition occurs at least once during measurement, the "**OV**" (Over) or "**Un**" (Under) indicator appears, to show that the processing data contain over-range or under-range data.

Important

During measurement, most of the keys such as the A/C/FLAT key and Level keys are inoperative. Only the following four keys can be used: Start/Stop, Pause/Cont, Mode, Light. All other settings must be made before starting the measurement.

During measurement, the Pause/Cont key can be used to pause and resume the measurement. During pause, the pause symbol (||) is shown. (Any pause intervals and the back-erase time if data back-erase is enabled are not included in the measurement time.)

If data back-erase was enabled in step 8, the data are indicated on the display, as shown below.

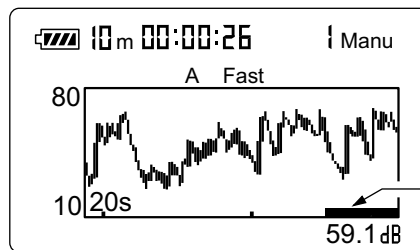

Measurement screen

11. When the measurement is completed, you can use the Mode key to switch between various ways of displaying the measurement result.
- When L_{Amax} is shown, the maximum sound level is being displayed.
- When L_{Amin} is shown, the minimum sound level is being displayed.
- If L_{Amax} and L_{Amin} are not shown, check whether L_{Amax} and L_{Amin} on the "Display" menu screen 4/5 are set to "On".
- If "Ov" (Over) is shown, the sound level data used for processing contained over-range data.
- If "Un" (Under) is shown, the sound level data used for processing contained under-range data.

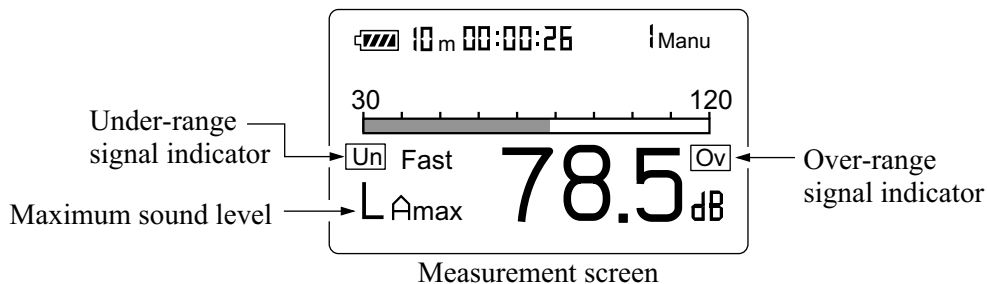

Note

It is also possible to use the Mode key during measurement to read the maximum or minimum sound level up to that point. (This applies only to the numeric level display. The bar graph indication shows the sound level.)

Changing the A/C/FLAT or Fast/Slow setting after measurement is completed has no effect on the displayed processing result.

Percentile Sound level (L_N) Measurement

The procedure for percentile sound level measurement is described below. It is very similar to the measurement of equivalent continuous sound level. Preparations as described in the previous chapter must be completed first.

1. Turn the unit on by pressing the Power key.
2. Select the frequency weighting with the A/C/FLAT key. For normal measurements, select the "A" setting.
3. Use the Fast/Slow key to select the time weighting (dynamic characteristics). Normally, the "Fast" setting should be used.

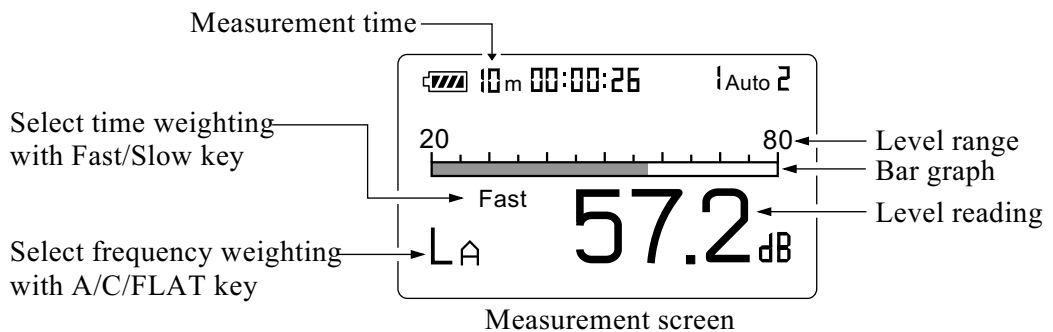

4. Use the Level Range keys to select the level range. Choose a setting in which the bar graph indication registers to about the middle of the range.

If an over-range or under-range condition has occurred at least once during the measurement, the "Ov" (Over) or "Un" (Under) indication is shown on the display, to indicate that over-range or under-range data were included in the sound level measurement values used for processing.

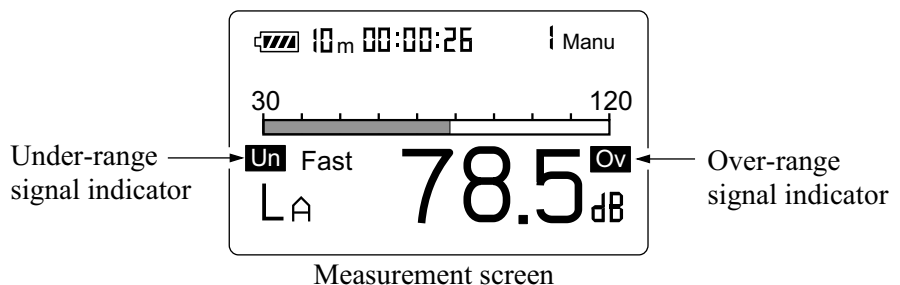

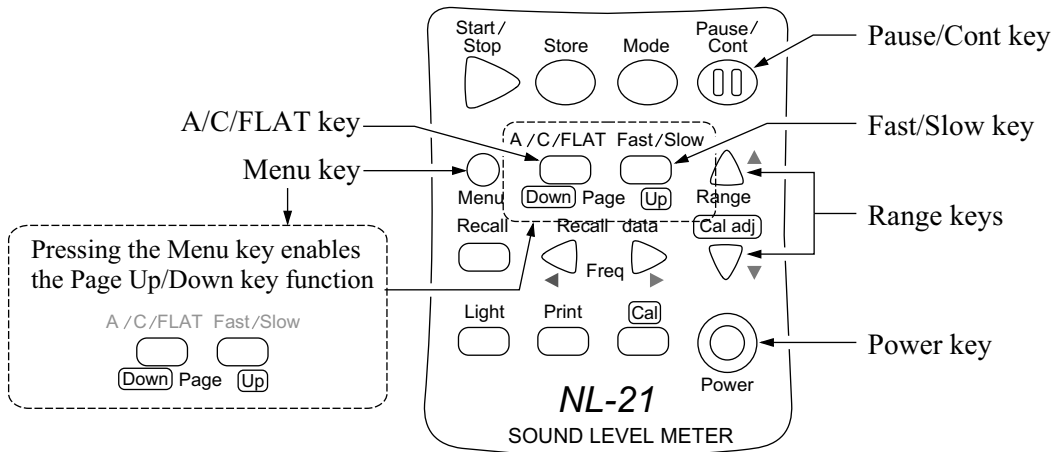

5. Use the menu to set the measurement time.
Press the Menu key to call up the menu screen 1/5.
6. Use the ▲ and ▼ keys to move the cursor to the "Meas. time" item, and use the ◀ and ▶ keys to select the measurement time.
Manual → 10 sec → 1 min → 5 min → 10 min → 15 min → 30 min → 1 hour → 8 hours → 24 hours → Manual → ...
When Manual is selected, the measurement time is controlled by the operator. The maximum time is 200 hours.

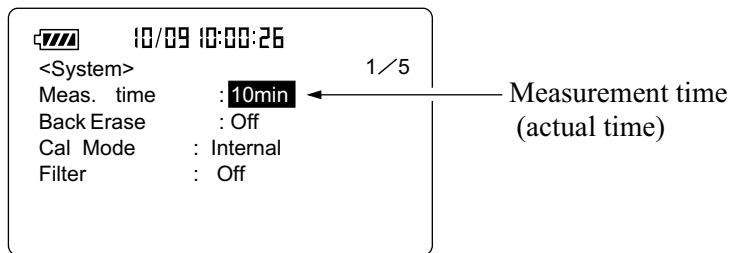

Menu screen 1/5

Important

Because sampling for L_N is performed at 100 ms intervals, a measurement time of 10 seconds or less will not yield correct results.

7. Use the Page Up/Down keys to display the menu screen 4/5.
8. In the default condition, the unit is set up to measure the percentile sound level L_5 , L_{10} , L_{50} , L_{90} , and L_{95} . These settings can be changed to any value between L_1 and L_{99} (up to five settings).

Use the ▲ and ▼ keys to move the highlight and use the ◀ and ▶ keys to change the time percentile number and to toggle the setting between "On" and "Off".

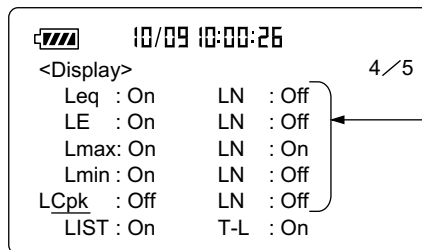

L_N : Percentile sound level
Set required L_N to On.

L_N can be set in the range from 1 to 99.

Menu screen 4/5

Important

Establish these settings before starting the measurement. If a setting is changed later, the measurement will be invalid.

9. To use the data exclusion (back-erase) function, please refer to page 77.

Note

In addition to the regular pause function it is also possible to exclude (back-erase) data from the immediately preceding 5 seconds.

10. Press the Menu key to return to the measurement screen.

11. Press the Start/Stop key to start the measurement.

During measurement, the ► symbol flashes and the elapsed measurement time is displayed.

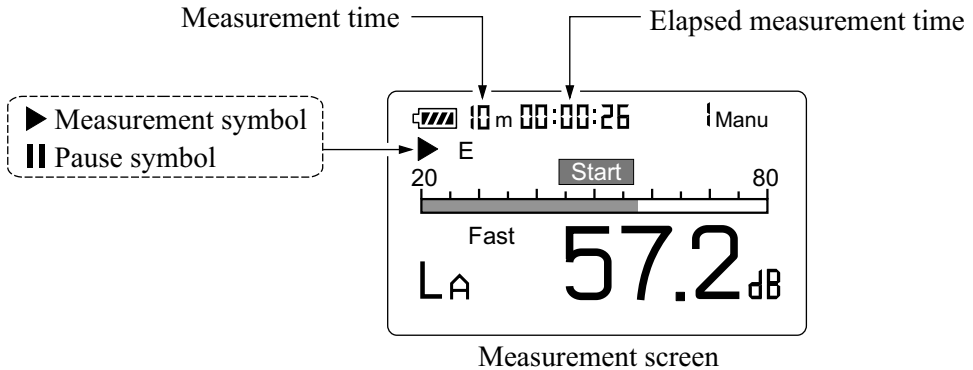

When the measurement time set in step 6 has elapsed, the measurement terminates automatically. When wishing to terminate the measurement earlier, press the Start/Stop key.

If no display (arbitrary measurement time) was selected, the Start/Stop key must be used to conclude the measurement.

If an under-range condition or over-range condition occurs at least once during measurement, the "Ov" (Over) or "Un" (Under) indicator appears, to show that the processing data contain over-range or under-range data.

Important

During measurement, most of the keys such as the A/C/FLAT key and Level keys are inoperative. Only the following four keys can be used: Start/Stop, Pause/Cont, Mode, Light. All other settings must be made before starting the measurement.

During measurement, the Pause/Cont key can be used to pause and resume the measurement. During pause, the pause symbol (||) is shown. (Any pause intervals and the back-erase time if data back-erase is enabled are not included in the measurement time.)

If data back-erase was enabled in step 9, the data are indicated on the display, as shown below.

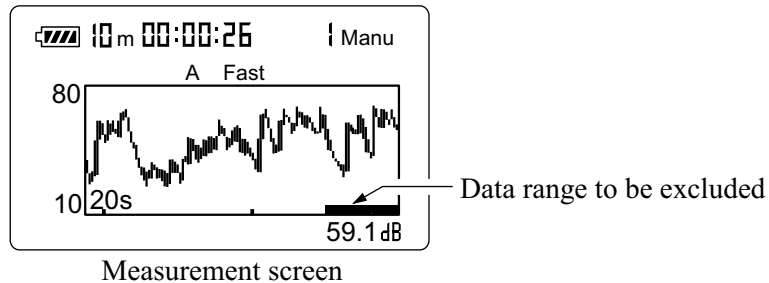

12. When the measurement is completed, you can use the Mode key to switch between various ways of displaying the measurement result. You can display the percentile sound levels selected in step 8, either sequentially or simultaneously.

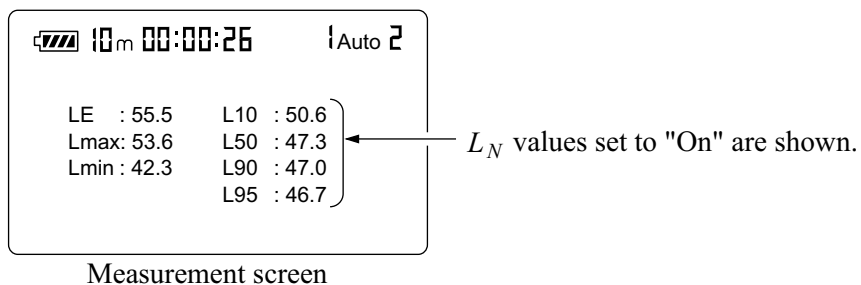

Note

It is also possible to use the Mode key during measurement to read the percentile sound level up to that point. (This applies only to the numeric level display. The bar graph indication shows the sound level.)

If "Ov" (Over) is shown, the sound level data used for processing contained over-range data.

If "Un" (Under) is shown, the sound level data used for processing contained under-range data.

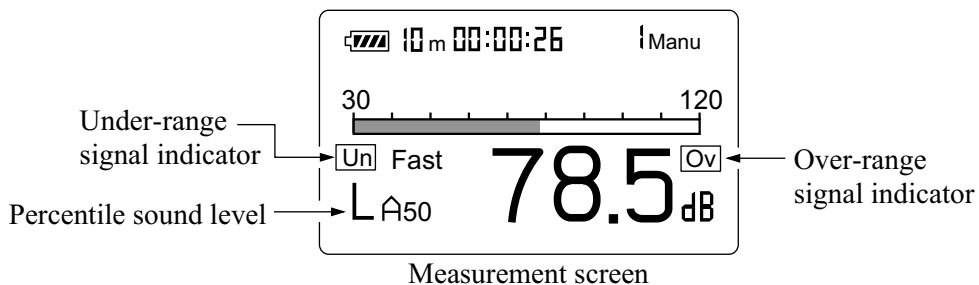

Note
Changing the A/C/FLAT or Fast/Slow setting after measurement is completed has no effect on the displayed processing result.

Measurement of Auxiliary Processing Values (L_{peak} , L_{Cpeak} , L_{Ceq} , L_{Atm5} , L_{AI} , L_{A1eq})

This unit can simultaneously measure L_{eq} , L_{E} , L_{max} , L_{min} , L_{N} plus one of the items listed below.

L_{peak}	: FLAT peak sound level
L_{Cpeak}	: C-weighted peak sound level
L_{Ceq}	: C-weighted equivalent continuous sound level
L_{Atm5}	: Takt-max sound level
L_{AI}	: Impulse sound level
L_{A1eq}	: Impulse equivalent continuous sound level

The peak sound level represents sound pressure waveform peak before averaging by time-based weighting.

L_{peak} is the waveform peak level of the flat-response signal and L_{Cpeak} of the C-weighted response signal.

The impulse sound pressure level L_{AI} is the impulse level with time weighting. It can only be used on the normal screen when A-weighted characteristics are selected.

The impulse equivalent continuous sound pressure level L_{A1eq} is the equivalent level calculated for time-weighted impulse sound pressure level. It can only be used on the normal screen when A-weighted characteristics are selected.

The power average of maximum sound pressure level in a given interval (5 seconds) L_{Atm5} is the power average of the highest sound pressure level over a 5-second period. It can only be used on the normal screen when A-weighted characteristics are selected.

L_{Ceq} is the C-weighted equivalent continuous sound pressure level. It can be measured along with the equivalent continuous sound pressure level. It cannot be used on the normal screen when C-weighted characteristics are selected.

The explanation assumes that the steps listed in the preceding chapter "Preparations" are completed.

Important

Auxiliary processing functions cannot be used in conjunction with the optional filters (octave filter, universal filter). The auxiliary processing functions are disabled when the 1/1, 1/3 octave filter or universal filter is On. Set the display of auxiliary processing values to Off, using the display menu screen (4/5).

1. Turn the unit on by pressing the Power key.
Select the frequency weighting with the A/C/FLAT key.
2. Use the menu to set the measurement time.
Press the Menu key to call up the menu screen.
3. Use the Page Up/Down keys to display the menu screen 4/5.
If L_{xx} : Off is displayed, use the ▲ and ▼ keys to move the highlight to "Off", and use the ◀ and ▶ keys to set the item to "On".
Set the L_{xx} for the measurement.
Use the ▲ and ▼ keys to move the highlight to " L_{xx} ", and use the ◀ and ▶ keys to select the L_{xx} .
 L_{Atm5} , L_{AI} , and L_{A1eq} can only be set to "On" when A weighting is selected for main processing.
 L_{Ceq} can only be set to "On" when A weighting or Flat response is selected for main processing.

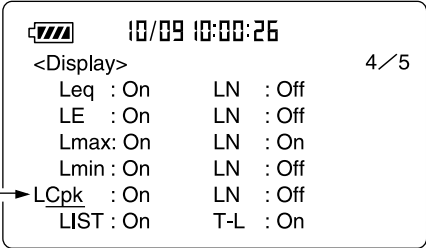
<p>L_{peak} : Peak sound level</p> <p>L_{Cpeak} : C-weighted peak sound level</p> <p>L_{Ceq} : C-weighted equivalent continuous sound level</p> <p>L_{Atm5} : Power average of maximum sound level in a given interval</p> <p>L_{AI} : Impulse sound level</p> <p>L_{A1eq} : Impulse equivalent continuous sound level</p>	 <p>Menu screen 4/5</p>
--	---

4. Use the Page Up/Down keys to display the menu screen 1/5.
 Use the ▲ and ▼ keys to move the cursor to the "Meas. time" item, and use the ◀ and ▶ keys to select the measurement time.
 Manual → 10 sec → 1 min → 5 min → 10 min → 15 min → 30 min → 1 hour → 8 hours → 24 hours → Manual → ...

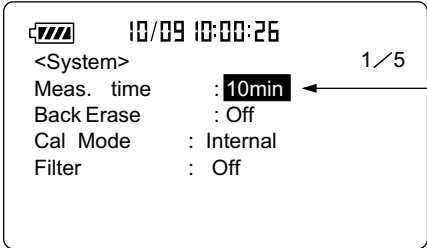
 <p>Menu screen 1/5</p>	<p>Measurement time (actual time)</p>
---	---------------------------------------

5. To use the data exclusion (back-erase) function, please refer to page 77.

Note

In addition to the regular pause function it is also possible to exclude (back-erase) data from the immediately preceding 5 seconds. However, when L_{Atm5} is selected, the back-erase function cannot be used.

6. Press the Menu key to return to the measurement screen.
7. Use the Level Range keys to select the level range. Choose a setting in which the bar graph indication registers to about the middle of the range.

If the "Ov" (Over) or "Un" (Under) indicators light up frequently, change the level range setting.

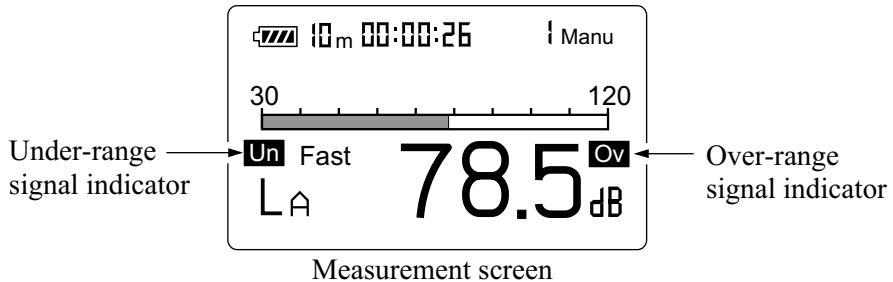

8. Press the Start/Stop key to start the measurement.

During measurement, the ► symbol flashes and the elapsed measurement time is displayed every one second.

When the measurement time set in step 4 has elapsed, the measurement terminates automatically. When wishing to terminate the measurement earlier, press the Start/Stop key.

If no display (arbitrary measurement time) was selected, the Start/Stop key must be used to conclude the measurement.

If an under-range condition or over-range condition occurs at least once during measurement, the "Ov" (Over) or "Un" (Under) indicator appears, to show that the processing data contain over-range or under-range data.

Important

During measurement, most of the keys such as the A/C/FLAT key and Level keys are inoperative. Only the following four keys can be used: Start/Stop, Pause/Cont, Mode, Light. All other settings must be made before starting the measurement.

During measurement, the Pause/Cont key can be used to pause and resume the measurement. During pause, the pause symbol (||) is shown. (Any pause intervals and the back-erase time if data back-erase is enabled are not included in the measurement time.)

If data back-erase was enabled in step 5, the data are indicated on the display, as shown below.

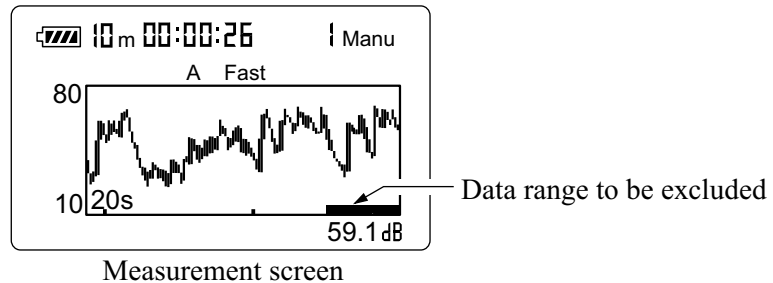

9. When the measurement is completed, you can use the Mode key to switch between various ways of displaying the measurement result.
 - If "Ov" (Over) is shown, the sound level data used for processing contained over-range data.
 - If "Un" (Under) is shown, the sound level data used for processing contained under-range data.

Level range		80 dB	90 dB	100 dB	110 dB	120 dB	130 dB
		C weighting	Measurement upper limit (dB)	91	101	111	121
Measurement lower limit (dB)	55		55	55	55	55	55
Flat	Measurement upper limit (dB)	91	101	111	121	131	141
	Measurement lower limit (dB)	60	60	60	60	60	60

NL-21/NL-31 peak measurement range

Important

L_{AI} is the time weighting level, but the display is updated when processing is started by pressing the Start key. When processing stops, the display update also stops. To measure L_{AI} only, setting of the "Meas. time" item to "Manual" is recommended.

Note

It is also possible to use the Mode key during measurement to read the equivalent continuous sound level up to that point. (This applies only to the numeric level display. The bar graph indication shows the sound level.)

Changing the A/C/FLAT or Fast/Slow setting after measurement is completed has no effect on the displayed processing result.

Back-Erase Function

When a measurement is being carried out and data are being processed, the Pause/Cont key can be used to pause the measurement (i.e. to exclude data from the point at which the key has been pressed), but it is also possible to exclude (back-erase) data from an interval of 5 seconds before the key was pressed.

The data that are to be excluded are shown at the bottom of the measurement screen.

To enable the back-erase function, proceed as follows.

1. Press the Menu key to display the menu screen 1/5.

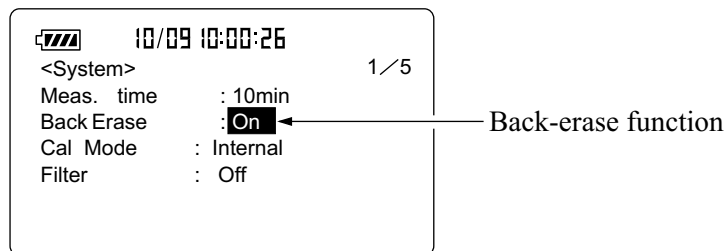

Menu screen 1/5

2. Use the ▲ and ▼ keys to move the highlight to the "Back Erase: Off" item.
3. Use the ◀ and ▶ keys to change the setting from "Off" to "5sec".

Press the menu key to return to the measurement screen.

The indication "E" is shown on the display, indicating that the data back-erase function has been enabled.

If the Pause key is pressed during processing, the data from the 5-second interval before the key was pressed are discarded.

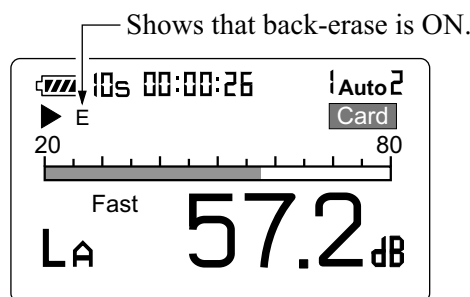

Measurement screen

Note

When L_{Atm5} is selected as auxiliary processing function, the data exclusion function cannot be used. The function also cannot be used during Auto1 store or Auto 2 store.

Store Operations

The NL-21/NL-31 incorporates a memory which can be used to store measurement data (sound level, L_p , L_{eq} and other processed values, measurement parameters such as frequency weighting, time weighting, etc.). This chapter describes how to store data in memory and how to recall data from memory. There are three different ways of storing data, as listed below.

Manual

In this mode, the operator stores the sound level and processed values in the memory manually. Pressing the Store key causes the current sound level, preselected processing values, and measurement parameters to be stored.

The internal memory or memory card can be selected as store target.

Up to 100 data sets can be stored in the internal memory. When storing on a memory card, the maximum is 100 data sets per file.

Compact flash card

Auto 1

This store mode becomes available when a memory card is inserted.

It is useful for recording the sound level waveform. When a 16-MByte memory card is used and the store cycle is set to 1s, data for up to 200 hours can be stored continuously. The store cycle can be set to 100 ms, 200 ms, 1 s, or $L_{Aeq,1\text{ sec}}$ (L_{Aeq} per second).

A timer mode which allows presetting the start and stop time is also available. When a 16-MByte memory card is used and the sampling cycle is set to 100 ms, data for up to 1.3 days can be stored continuously. *

Auto 2

This store mode becomes available when a memory card is inserted.

Up to 99999 data sets can be stored continuously. This mode is most suitable for long-term measurements. One data set contains all processed values, but not the sound level.

A timer mode which allows presetting the start and stop time is also available.

An interval measurement function which performs measurement for 10 minutes at every full hour is also available.

Important
Never turn off the unit or remove the memory card while a store operation is in progress. Otherwise internal data can be destroyed.
While a memory card is inserted in the card slot, the internal memory cannot be accessed, which means that data cannot be stored in the memory or read or printed from the memory. When wishing to access the internal memory, make sure that no memory card is inserted in the unit.

* The Maximum measurement period according to the sampling cycle.

Sampling cycle	Max. measurement period
100 ms	1.3 day
200 ms	2.6 day
1 s	8.3 day
$L_{Aeq,1 \text{ sec}}$	8.3 day

Manual Store

Storing Data in Memory

At the point where you press the Store key, the current sound level and all processed values are saved. Immediately after turning the unit on, no processing results exist. Therefore only the sound level gets stored.

If no memory card is inserted, data are stored in the internal memory. If a memory card is inserted, data are stored on the card.

The procedure for storing is as follows.

1. Insert a memory card in the card slot.
2. Turn the unit on.

To store data in the internal memory, verify that no memory card is inserted in the card slot, and verify that the indication " **Card** " is shown on the display, and then proceed to step 8.

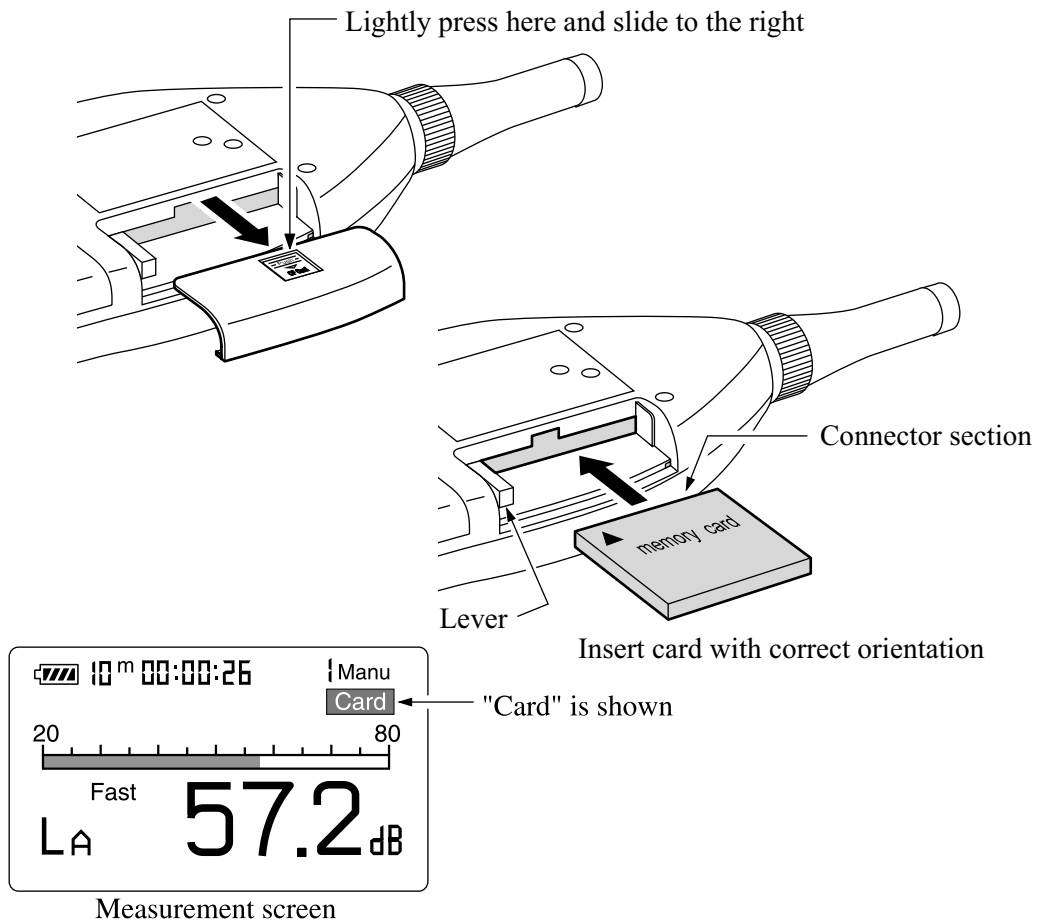

3. Press the Menu key to call up the menu screen.
4. Use the Page Up/Down keys to display the menu screen 2/5.
5. If the Store Mode item is not set to "Manual", use the ▲ and ▼ keys to move the highlight to the item and use the ◀ and ▶ keys to set it to "Manual".
6. Specify a file name (4 numeric digits) with the ◀ and ▶ keys.

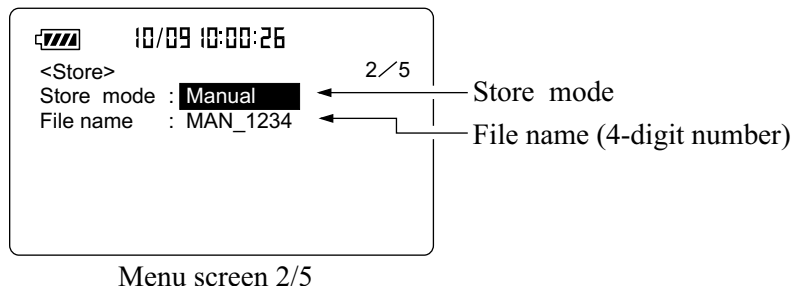

7. Press the Menu key to return to the measurement screen.

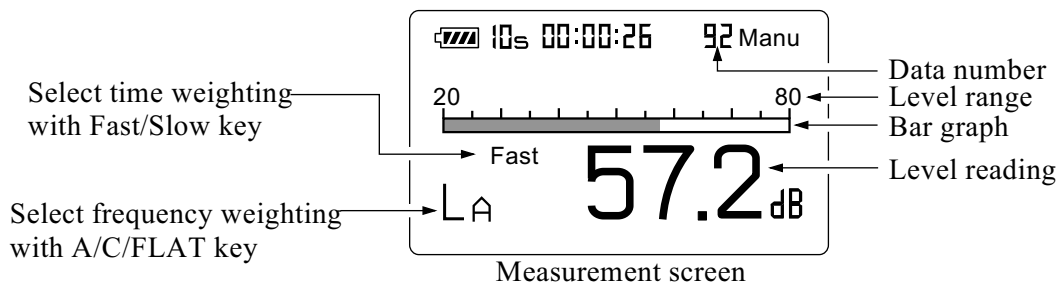

8. To store the sound level, proceed as follows. (To store processed values only, skip this step and continue with step 9.)
 - Verify that no processed data exist (processed values are 0.00 dB).
 - If there are processed values, turn the unit off and then on again.
 - Activate the sound level measurement display. Then proceed to step 10.

9. To store processed values, perform the measurement as described in the preceding chapter (except for "Sound level Measurement").
10. Select the data number for the store process.
The data number is shown on the screen.
You can use the ◀ and ▶ keys to set the data number to a value between 1 to 100. If there are already measurement data in the selected number, these data will be overwritten by the new data. To check whether data are present, perform the steps described in "Reading Stored Data" on pages 82 and 83.

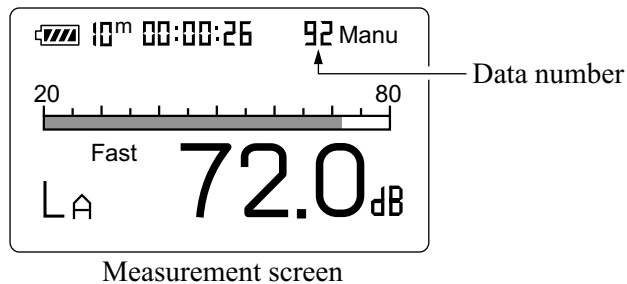

Note

During filter selection, the ◀ and ▶ keys serve to change the filter frequency.

The data number can be switched in one of two ways during filter selection.

- Switch to the recall screen, change the data number, and switch back to the measurement screen.
- On menu screen 1/5, set the filter to "Off", switch the data number on the measurement screen, and then again activate the filter on menu screen 1/5.

11. Press the Store key.

The sound level at point when the key was pressed is stored.

If processing measurement was carried out in step 9, the processed data are also stored in the same way.

The store process is completed in about one second, and the data number is incremented by 1. Pressing the Store key repeatedly allows you to consecutively store data.

The stored data comprise all information shown on the display (except for the battery indication), as well as the current date and time, start date and time of processing, measurement time, frequency weighting, time weighting (dynamic characteristics), and processing results.

The time/level graph shown on the display is not stored.

Important
The unit does not check whether data to be stored are present. When the Store key is pressed, the data in the currently selected data number are overwritten, even if no new data are available.

Note
When the data number 100 is reached, the indication does not change further and does not return to 1. When the Store key is pressed in this condition, the "100" indication flashes, but data are not stored. Pressing the ◀ and ▶ (Data No.) keys to select another number causes the indication to stop flashing, and data can be stored in the selected data number.

Reading Stored Data (From Internal Memory)

To read data stored in the internal memory with manual mode, proceed as follows.

Important

When the memory card is inserted in the card slot, the data stored in the internal memory cannot be read. Be sure to remove the card from the card slot then proceed as follows.

1. Verify that no memory card is inserted in the card slot. Turn the unit on.
2. Press the Recall key.
The recall screen appears.
3. Use the Recall Data ◀ and ▶ keys to select the data number in which the data were stored. The data are shown on the display.
When there are no data in a number, the display only shows "--.-".
Press the Mode key to switch between the stored sound level value and the various processing results.

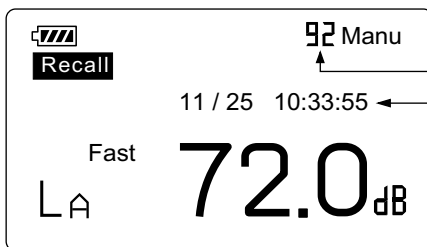

Recall screen

Data number
Data store time

When the display shows sound level,
the time shows when the store key is pressed
When the display shows processing result,
the time shows when the processing starts

Important

When wishing to check whether data are present in a data number, use the Mode key to switch the display to sound level and then verify whether data or "--.-" is shown on the display. If "--.-" is shown in other mode settings, that data number may still contain sound level value data.

4. To terminate the recall mode, press the Recall key once more.

Reading Stored Data (From Memory Card)

To read data stored in the memory card with manual mode, proceed as follows.
Verify that the memory card is inserted in the card slot.

1. Turn the unit on.
2. Press the Recall key to bring up the card recall screen.
The data are sorted by measurement start time, in descending order.

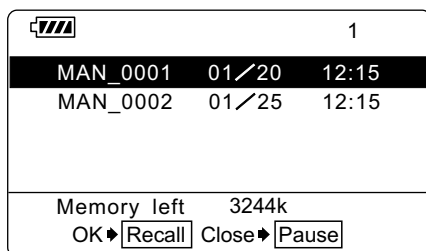

	1		
MAN_0001	01/20	12:15	
MAN_0002	01/25	12:15	
Memory left	3244k		
OK	Recall	Close	Pause

Recall screen

3. Use the Page Up/Down keys to go to the page with the desired file name.
4. Use the ▲ and ▼ keys to highlight the desired file name.
5. Press the Recall key.
The data of the selected file are shown on the display.
6. Use the ◀ and ▶ keys to view the data for the desired measurement elapsed time.
7. To terminate the recall mode, press the Recall key or the Pause key.
Then, press the Pause key.

Clearing Stored Data (From Internal Memory)

To clear data stored in the internal memory with manual mode, proceed as follows.

1. Verify that no memory card is inserted in the card slot.
2. Press the Menu key to call up the menu screen.
3. Use the Page Up/Down keys to display the menu screen 5/5.
4. Set the "Manual data clear" item to "On".

To clear (erase) the data, press the Start key. The manual data are cleared, and the unit returns to menu screen 5/5 with the "Manual data clear" item set to "Off".

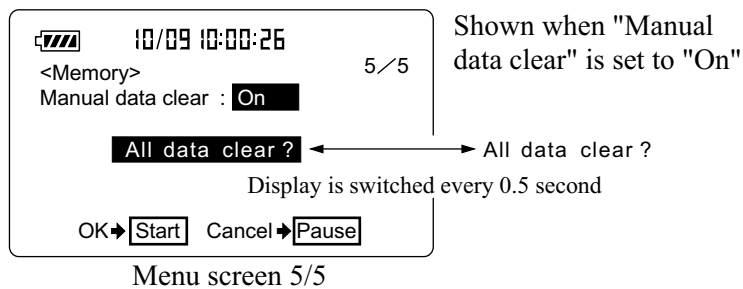

Clearing Stored Data (From Memory Card)

To clear data stored in the memory card with manual mode, proceed as follows.

1. Verify that the memory card is inserted in the card slot.
2. Press the Menu key to call up the menu screen.
3. Use the Page Up/Down keys to display the menu screen 5/5.
4. Set the "Card format" item to "On".

To clear (erase) the data, press the Start key. The manual data are cleared, and the unit returns to menu screen 5/5 with the "Card format" item set to "Off".

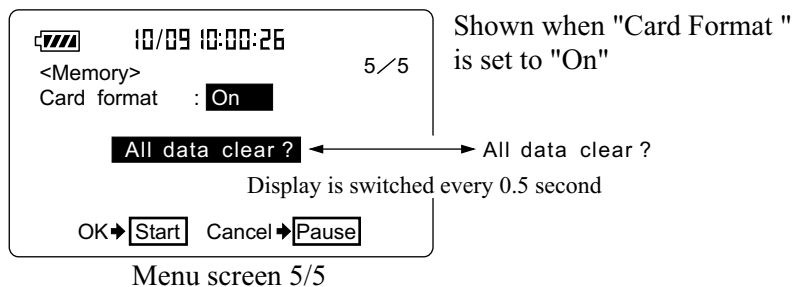

Note

It is not possible to clear only the data of a specified address, either in the memory of the unit or on the memory card.

On the memory card, it is not possible to clear only the data of a specified file. All data on the card are cleared.

When wishing to delete only specified files, perform the operation on a computer.

Auto 1

Using an optional memory card (compact flash card) allows storing sound level data for up to 200 hours of measurement (when set the sampling period to 1 s or $L_{Aeq, 1 \text{ sec}}$).

Storing Data

The procedure for Auto 1 storing is as follows.

Verify that the memory card is inserted in the card slot.

1. Turn the unit on.
2. Press the Menu key to call up the menu screen.
3. Use the Page Up/Down keys to display the menu screen 2/5.
4. If the Store Mode item is not set to "Auto 1", use the ▲ and ▼ keys to move the highlight to the item and use the ◀ and ▶ keys to set it to "Auto 1". When using timer mode, select "Timer Auto 1".
5. Use the ▼ key to select "File name".
6. Specify the last four digits of "AU 1_0000" with the ◀ and ▶ keys to set the file name.

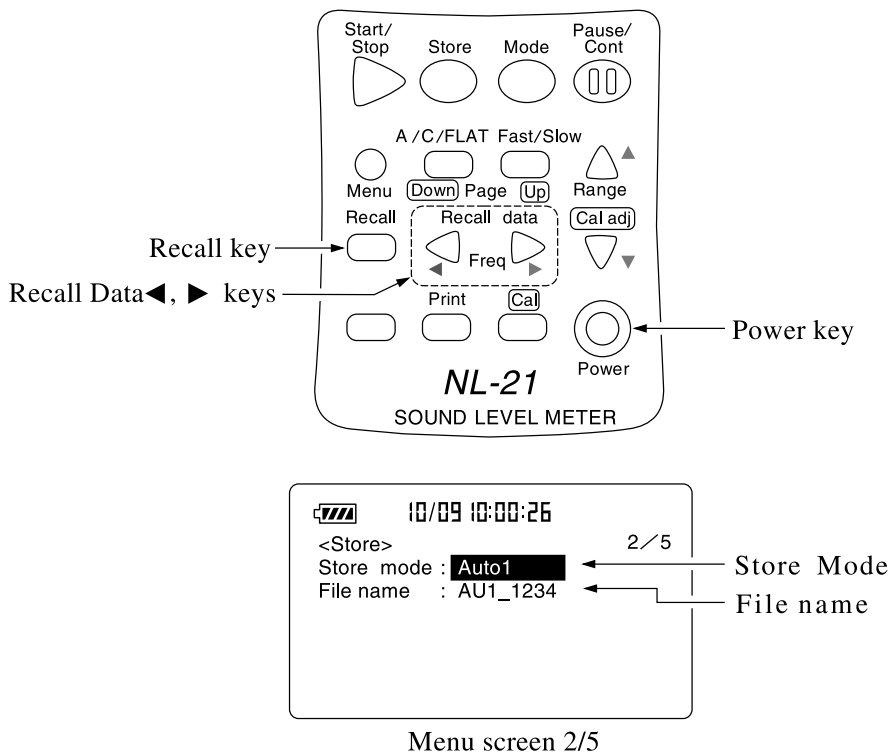

7. Use the "Auto 1 Samp." item to set the sampling interval for the sound level or equivalent continuous sound level. Use the ▼ key to move the highlight, and use the ◀ and ▶ keys to select the setting.
For sound level measurement, you can select 100 ms, 200 ms, or 1 s.
For equivalent continuous sound level measurement, the $L_{Aeq,1\text{ sec}}$ setting causes the L_{eq} to be continuously stored at 1-second intervals.
For normal Auto 1 store without using the timer mode, proceed to step 9.
8. Set the "Start" date and time (month, day, hour, minute), and then the "Stop" date and time (month, day, hour, minute). (There is no setting for the year.)
9. Use the Page Up/Down keys to display the menu screen 1/5.
Use the ▲ and ▼ keys to move the cursor to the "Meas. time" item, and use the ◀ and ▶ keys to select the measurement time.
Manual → 10 sec → 1 min → 5 min → 10 min → 15 min → 30 min → 1 hour → 8 hours → 24 hours → Manual → ...
10. Press the Menu key to return to the measurement screen.
11. Set the frequency weighting (A/C/FLAT) and time weighting (Fast/Slow) to the desired setting.
12. Use the Level Range keys to select the level range. When measuring environmental noise, select the range of 100, 110 or 120 dB.
If the "Ov" (Over) or "Un" (Under) indicators light up frequently, change the level range setting.

13. Press the Store key.

For normal Auto 1 store, **Start** lights up for 1 second, and the **▶** and **Store** indication flash to indicate that store is being carried out. The elapsed time is also shown.

In timer mode, the Auto 1 standby screen as shown below is displayed, and the unit goes into power save mode.

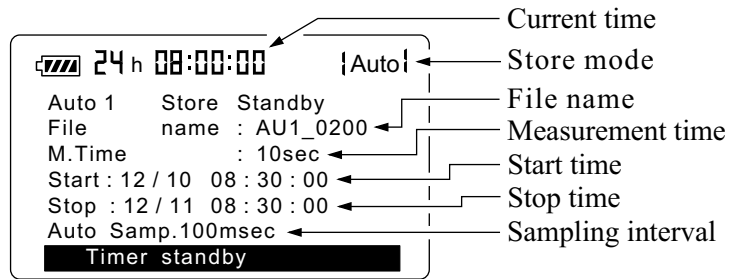

Auto 1 standby screen

Note

In power save mode, power consumption is about 1/3 as compared to regular operation.

When you press the Start/Stop key or the Store key in power save mode, measurement is terminated.

When you press any other key, the normal screen is restored. When no further key is pressed, the unit will revert to the power save mode after about 7 seconds. 10 seconds before the scheduled start of measurement, the normal screen automatically comes up, and measurement starts at the preset time.

If the start time and stop time are set to the same values, measurement is not carried out.

Important

During store, most of the keys such as the A/C/FLAT key and Fast/Slow key are inoperative. Only the following three keys can be used: Start/Stop, Pause/Cont, Light. All other settings must be made before starting the store.

During store, the Pause/Cont key can be used to pause and resume the store. During pause, the pause symbol (||) is shown.

14. During normal Auto 1 store, the data store process terminates when the measurement time has elapsed.

To stop the process before that, press the Start/Stop key or the Store key.

During Timer Auto 1 store, the data store process terminates when the measurement time has elapsed, or when the preset stop time is reached.

Note

Elapsed measurement time and data number
If a 100 ms interval is selected for Auto 1 store, 10 data will be stored each second. This means that 100 data will be stored after 10 seconds. When a 1-second interval is selected, 10 data will be stored after 10 seconds.

Note

During Auto 1 store, the data exclusion (back-erase) function cannot be used.

15. The timer mode measurement has completed normally, the indication below is shown.

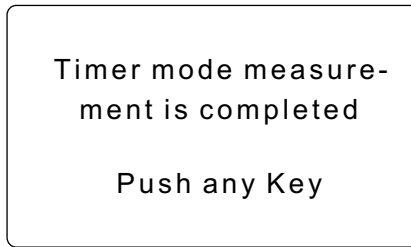

Elapsed time display

During Auto 1 store, the store address is converted into elapsed time for display. In the example below, the sampling interval is 100 ms, which yields 10 data per second. The indication means that data number 262 is being stored.

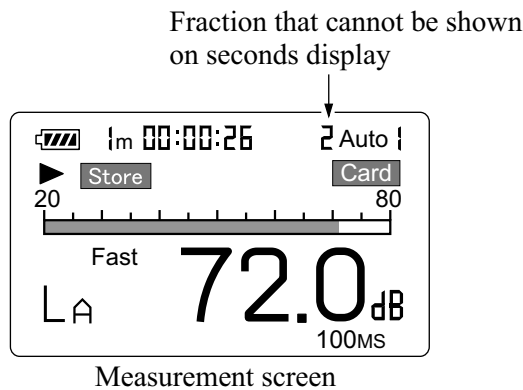

When 100 hours have elapsed, the top digit of the address display becomes "1" as shown below.

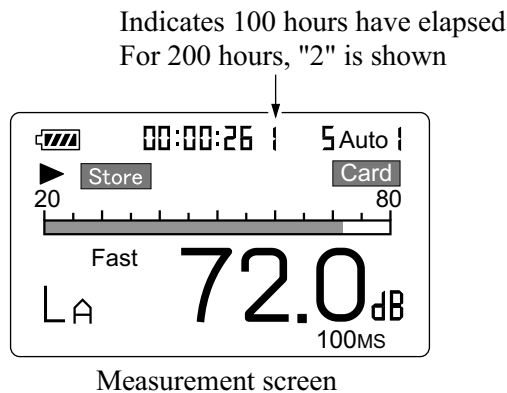

16. When 200 hours have elapsed, "Data memory full" is shown.



Reading Stored Data

To read data stored in Auto 1 mode, proceed as follows.

Verify that the memory card is inserted in the card slot.

1. Turn the unit on.
2. Press the Recall key to bring up the card recall screen.

The data are sorted by measurement start time, in descending order.

		1
MAN_0001	01/20	13:10
AU1_1100	01/20	12:15
AU2_0001	01/22	15:00
AU1_0002	01/23	08:30
Memory left	3244k	
OK  Recall		Close  Pause

Card recall screen

3. Use the Page Up/Down keys to go to the page with the desired file name.
4. Use the ▲ and ▼ keys to highlight the desired file name.
5. Press the Recall key.
The data of the selected file are shown on the display.
6. Use the ◀ and ▶ keys to view the data for the desired measurement elapsed time.
7. To terminate the recall mode, press the Recall key or the Pause key.
Then, press the Pause key.

Note

When recalling Auto 1 store data, the displayed time is always the measurement start time, regardless of the elapsed time for the data currently displayed. It is not the time when the displayed data were stored.

Auto 2

Using an optional memory card (compact flash card) allows continuous storing of up to 99999 data sets of processed values.

One data set comprises the equivalent continuous sound level, sound exposure level, maximum value, minimum value, and percentile sound level (5 selectable values), resulting in a total of 9 data. If auxiliary processing is set to "On", the total is 10 data.

Storing Data

The procedure for Auto 2 storing is as follows.

Verify that the memory card is inserted in the card slot.

1. Turn the unit on.
2. Press the Menu key to call up the menu screen.
3. Use the Page Up/Down keys to display the menu screen 2/5.
4. If the Store Mode item is not set to "Auto 2", use the ▲ and ▼ keys to move the highlight to the item and use the ◀ and ▶ keys to set it to "Auto 2". To use the timer function, select "Timer Auto 2".

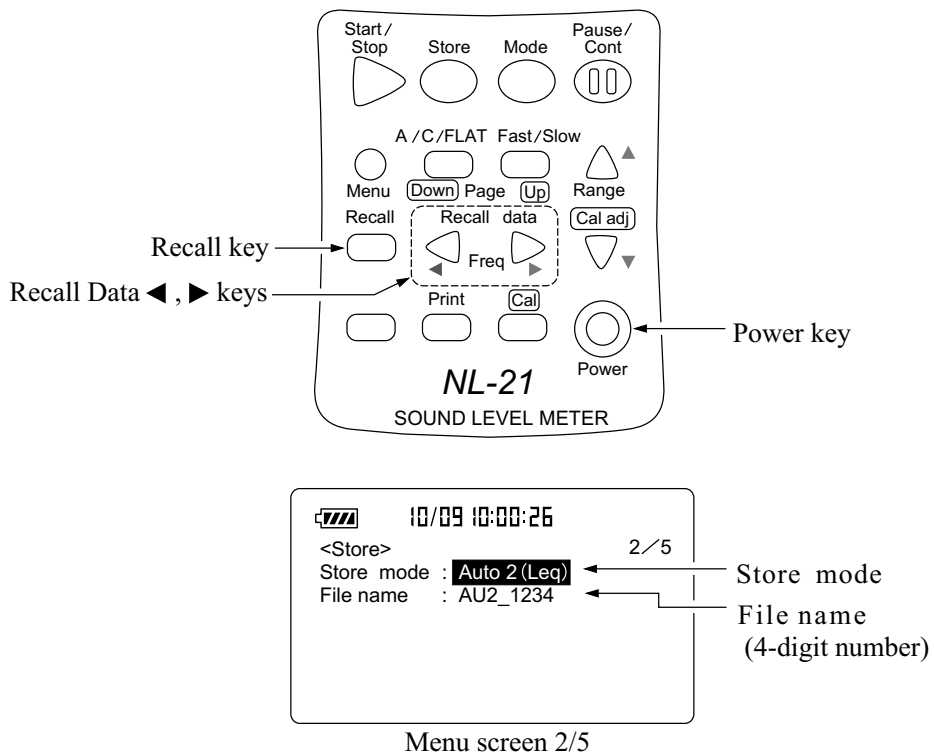

5. Use the ▼ key to select "File name".
6. Specify the last four digits of "AU 2_0000" with the ▲ and ▼ keys to set the file name.

For normal Auto 2 store without using the timer mode, proceed to step 11.

7. Set the "Start" date and time (month, day, hour, minute), and then the "Stop" date and time (month, day, hour, minute). (There is no setting for the year.)
8. Use the ▲ and ▼ keys to move the cursor to the "Interval" item, and use the ◀ and ▶ keys to select the measurement cycle.

When this setting is "OFF", processing and storing is carried out continuously using the measurement time setting.

Interval setting

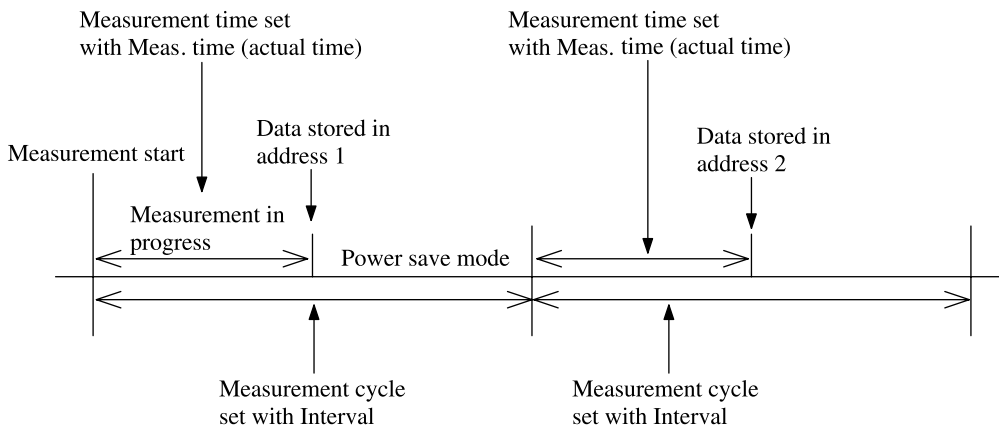

Note

When setting the measurement parameters, the measurement time (Meas. time) setting may not exceed the measurement cycle (Interval) setting. Otherwise an error message will be displayed when attempting to start measurement.

If the start time and stop time are set to the same values, measurement is not carried out.

9. Use the Page Up/Down keys to display the menu screen 1/5.
 Use the ▲ and ▼ keys to move the cursor to the "Meas. time" item, and use the ◀ and ▶ keys to select the measurement time.
 Manual → 10 sec → 1 min → 5 min → 10 min → 15 min → 30 min
 → 1 hour → 8 hours → 24 hours → Manual → ...

Note
Do not select "Manual" for the measurement time.

10. Use the ▼ key and make the setting for the data exclusion (back-erase) function. (For Timer Auto 2 store, the function cannot be used.)
11. Press the Menu key to return to the measurement screen.
12. Set the frequency weighting (A/C/FLAT) and time weighting (Fast/Slow) to the desired setting.
13. Use the Level Range keys to select the level range. Choose a setting in which the bar graph indication registers to about the middle of the range.
 If the "Ov" (Over) or "Un" (Under) indicators light up frequently, change the level range setting.
 The measurement time determines the period for which 1 set of processed data is determined. In Auto 2 mode, a maximum of 99999 data sets can be stored. This means that measurement can continue for a period of 99999 times the measurement time setting.
 To set the values (L_1 to L_{99}) for the percentile sound level, perform step 8 on page 67.
14. Press the Store key.

Normal Auto 2 store

Start lights up for 1 second, and the ► and **Store** indication flash to indicate that store is being carried out. The elapsed time (time that 1 data set has been measured) is also shown.

The address always starts from 1.

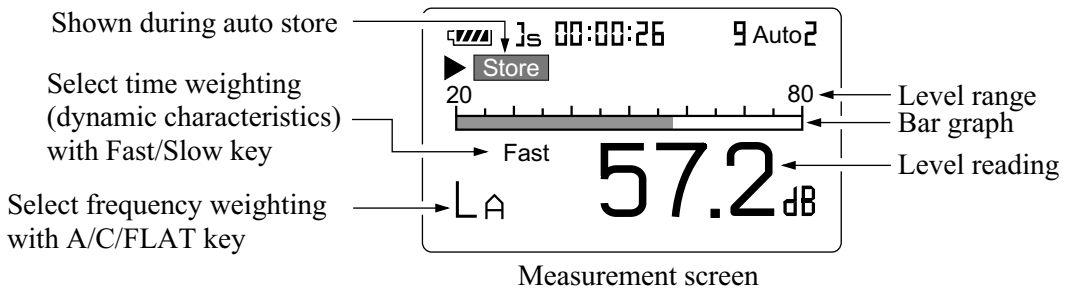

Important

During store, most of the keys such as the A/C/FLAT key and Fast/Slow key are inoperative. Only the following four keys can be used: Start/Stop, Pause/Cont, Mode, Light. All other settings must be made before starting the store.

During store, the Pause/Cont key can be used to pause and resume the store.

During pause, the pause symbol (||) is shown.

The pause time is not counted as store time.

When Timer Auto 2 is used

The Auto 2 standby screen as shown below is displayed, and the unit goes into power save mode.

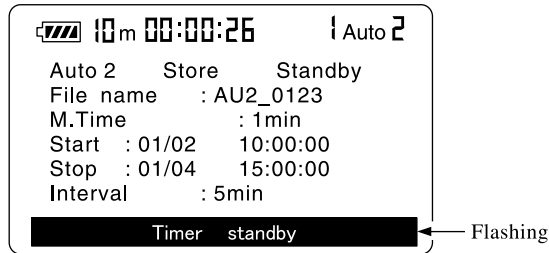

Auto2 Standby screen

Note

In power save mode, power consumption is about 1/3 as compared to regular operation.

When you press the Start/Stop key or the Store key in power save mode, measurement is terminated.

When you press any other key, the normal screen is restored. When no further key is pressed, the unit will revert to the power save mode after about 7 seconds.

10 seconds before the scheduled start of measurement, the normal screen automatically comes up, and measurement starts at the preset time.

If the start time and stop time are set to the same values, measurement is not carried out.

15. When 99999 data sets have been reached, the data store process terminates.
To stop the process earlier, press the Start/Stop key or the Store key. During Timer Auto 2 store, the data store process also terminates when the preset stop time is reached.
16. When 99999 data sets have been reached, "Data memory full" is shown.

17. The timer mode measurement has completed normally, the indication below is shown.

Timer mode measurement is completed

Push any Key

Reading Stored Data

To read data stored in Auto 2 mode, proceed as follows.

Verify that the memory card is inserted in the card slot.

1. Turn the unit on.
2. Press the Recall key to bring up the card recall screen.
The data are sorted by measurement start time, in descending order.

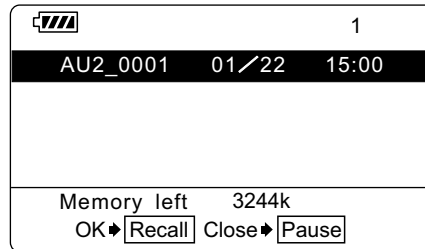

Card recall screen

3. Use the Page Up/Down keys to go to the page with the desired file name.
4. Use the ▲ and ▼ keys to highlight the desired file name.
5. Press the Recall key.
The data of the selected file are shown on the display.
6. Use the ◀ and ▶ keys to view the data for the desired measurement elapsed time.
7. To terminate the recall mode, press the Recall key or the Pause key.
Then, press the pause key.

Note

When a specific processing result is not displayed, activate the menu screen and set display of the respective item to "On".

This does not apply to auxiliary processing items. Such an item must already have been set to "On" before measurement.

Note

When auxiliary processing item L_{AI} is selected for Auto 2 store data.

For L_{AI} , the level value at the moment when the measurement time has elapsed and data are entered in the respective address is stored.

Timer operation example

Because the timer of this unit does not allow setting the year, a setting such as shown below will result in measurement end after about a year.

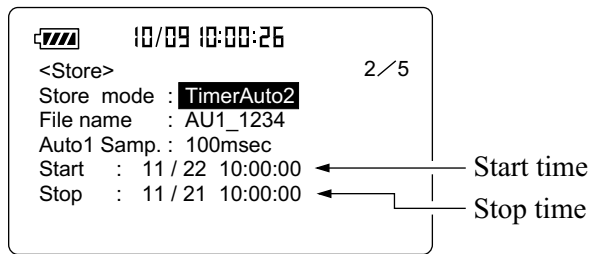

Menu screen 2/5

Memory Card

Memory Card

Using a memory card

Open the card compartment and insert the memory card.

To remove the card, push the lever in.

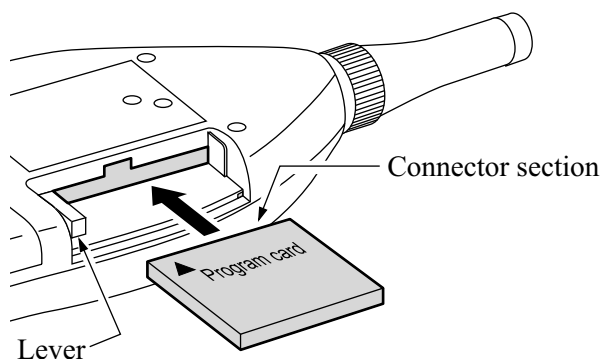
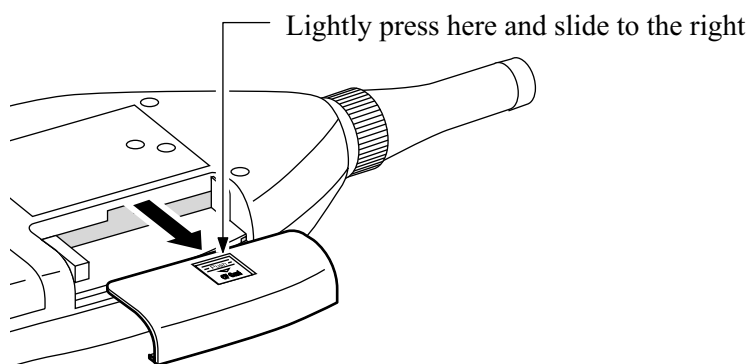

Insert card with correct orientation

Important

Be sure to turn the unit off, before inserting and removing the card.

Data size

The necessary data size for Auto 1 store

Measurement time	Data size (MByte)		
	100 ms	200 ms	1 s
1 hour	0.5	0.2	0.05
8 hours	3.8	1.9	0.4
24 hours (1 day)	11.5	5.8	1.2
3 days	34.6	17.3	3.5
7 days	80.8	40.4	8.1
Manual	96.1	48.1	9.6

Relationship between measurement time and data size

For example, when wishing to carry out the measurement with 100 msec sampling for 24 hours, the necessary data size is 11.5 MBytes from the above table. The necessary compact flash card size is 11.5 MBytes and more for this measurement.

When carrying out Auto 2 store, 120-Byte capacity per one data sets is necessary.

For example, when carrying out 10-minute measurement for 1 week continuously, 1008 data sets are stored. Therefore $1008 \times 120 =$ approx. 121-kByte capacity is necessary.

When carrying out Manual store, approx. 25-kByte capacity for one file (max. 100 data sets) is necessary. In this case, the necessary capacity is determined by the file, not by the number of data sets. Therefore storing 1 data set and storing 100 data sets need the same capacity.

Memory Card Type

Use memory cards from Rion Co., Ltd.

The memory cards optional from Rion are CompactFlash™ cards.

* CompactFlash™ is a registered trademark of SanDisk.

Some memory cards differ in specifications even if they are the same type from the same manufacturer. Correct function therefore is not assured if using other cards except those optional from Rion. Be sure to use only Rion cards.

Note
When attempting to read data from a memory card written in the NL-21/NL-31 on a computer, for example to import the data into spreadsheet software, some applications may not be able to recognize the file names on the card. In such a case, you should first change the file name by adding the extension ".txt" (for example "AU1-0001.txt"). Then read the file into the application as a text file.

Store Data Format

Data stored on the memory card are in CSV format. The files on the card are stored in different subdirectories which are created automatically.

Manual store

The file name entered via the menu screen is used for the last 4 characters of the subdirectory name.

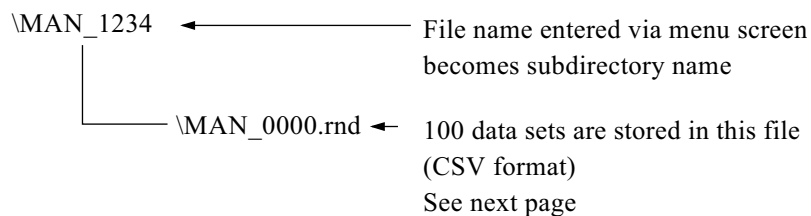

Address	Frequency weight,		Center/High pass filter cutoff,		Low Pass filter cutoff,		Store time,		Lp, Over, Under,	
	Freq	Time-weight, Filter,	Center/Hi-	Low Pass	Low Pass	Store time,	Lp, Over, Under,			
1	A,	Fast, 1/1 oct,	1 kHz,	-,	2001/2/25 12:00,	41.7, -, Under,				
2	A,	Fast, 1/1 oct,	AP,	-,	2001/2/25 12:05,	45.8, -, Under,				
3	A,	Fast, 1/1 oct,	63 Hz,	-,	2001/2/25 12:10,	34.7, -, Under,				
4	A,	Fast, 1/3 oct,	AP,	-,	2001/2/25 12:20,	46.5, -, Under,				
5	A,	Fast, 1/3 oct,	1 kHz,	-,	2001/2/25 12:35,	38.3, -, Under,				
6	A,	Fast, 1/3 oct,	6.3 kHz,	-,	2001/2/25 13:00,	47.6, -, Under,				
7	A,	Fast, 1/3 oct,	1.6 kHz,	-,	2001/2/25 14:00,	55.4, -, Under,				
8	A,	Fast, 1/1 oct,	16 Hz,	-,	2001/2/25 14:10,	56.3, -, Under,				
9	A,	Fast, Univ.,	Off,	1 kHz,	2001/2/25 14:20,	60.3, -, Under,				
10	A,	Fast, Univ.,	12.5 Hz,	Off,	2001/2/25 15:35,	49.2, -, Under,				
11	A,	Fast, Univ.,	31.5 Hz,	8 kHz,	2001/2/25 16:25,	48.3, -, Under,				

Store information for sound levels

Freq	Frequency weight,		Center/High pass filter cutoff,		Low Pass filter cutoff,		Measurement time,	
	Time-weight, Filter,	Center/Hi-	Low Pass	Beginning time,	Time setting, Measur.			
A,	Fast, 1/1 oct,	250 Hz,	-,	2001/2/25 12:00,	10 min, 00:10:00,			
A,	Fast, 1/1 oct,	250 Hz,	-,	2001/2/25 12:05,	10 min, 00:10:00,			
A,	Fast, 1/1 oct,	250 Hz,	-,	2001/2/25 12:10,	10 min, 00:10:00,			
A,	Fast, 1/1 oct,	250 Hz,	-,	2001/2/25 12:20,	10 min, 00:10:00,			
A,	Fast, 1/1 oct,	250 Hz,	-,	2001/2/25 12:35,	10 min, 00:10:00,			
A,	Fast, 1/1 oct,	250 Hz,	-,	2001/2/25 13:00,	10 min, 00:10:00,			
A,	Fast, 1/3 oct,	1 kHz,	-,	2001/2/25 14:00,	10 min, 00:10:00,			
A,	Fast, 1/3 oct,	1 kHz,	-,	2001/2/25 14:10,	10 min, 00:10:00,			
A,	Fast, Univ.,	Off,	Off,	2001/2/25 14:20,	10 min, 00:10:00,			
A,	Fast, Univ.,	Off,	Off,	2001/2/25 15:35,	10 min, 00:10:00,			
A,	Fast, Univ.,	Off,	Off,	2001/2/25 16:25,	10 min, 00:10:00,			

Store information for processing values

Leq,	LE,	Lmax,	Lmin,	x1,	Lx1,	x2,	Lx2,	x3,	Lx3,	x4,	Lx4,	x5,	Lx5,
87.5,	100.9,	101.3,	37.1,	5,	95.8,	10,	92.5,	50,	45.5,	90,	39,	95,	38.6,
87.5,	100.9,	101.3,	37.1,	5,	95.8,	10,	92.5,	50,	45.5,	90,	39,	95,	38.6,
87.5,	100.9,	101.3,	37.1,	5,	95.8,	10,	92.5,	50,	45.5,	90,	39,	95,	38.6,
87.5,	100.9,	101.3,	37.1,	5,	95.8,	10,	92.5,	50,	45.5,	90,	39,	95,	38.6,
87.5,	100.9,	101.3,	37.1,	5,	95.8,	10,	92.5,	50,	45.5,	90,	39,	95,	38.6,
87.5,	100.9,	101.3,	37.1,	5,	95.8,	10,	92.5,	50,	45.5,	90,	39,	95,	38.6,
79.6,	91.6,	95.8,	30.4,	5,	87.8,	10,	83.8,	50,	34.2,	90,	32.1,	95,	31.7,
79.6,	91.6,	95.8,	30.4,	5,	87.8,	10,	83.8,	50,	34.2,	90,	47.5,	95,	31.7,
91.3,	104.6,	108.6,	45,	5,	100.2,	10,	91,	50,	68.3,	90,	47.5,	95,	46.2,
91.3,	104.6,	108.6,	45,	5,	100.2,	10,	91,	50,	68.3,	90,	47.5,	95,	46.2,
91.3,	104.6,	108.6,	45,	5,	100.2,	10,	91,	50,	68.3,	90,	47.5,	95,	46.2,

Store information for processing values

y,	Ly,	Over,	Under,	Pause
Lppeak,	73.4,	-,	Under,	Pause
Lppeak,	73.4,	-,	Under,	Pause
Lppeak,	73.4,	-,	Under,	Pause
Lppeak,	73.4,	-,	Under,	Pause
Lppeak,	73.4,	-,	Under,	Pause
Lppeak,	73.4,	-,	Under,	Pause
Lppeak,	72.3,	Over,	Under,	Pause
Lppeak,	72.3,	Over,	Under,	Pause
Lppeak,	133.4,	-,	Under,	Pause
Lppeak,	133.4,	-,	Under,	Pause
Lppeak,	133.4,	-,	Under,	Pause

Store information for processing values

Auto 1 store

The file name entered via the menu screen is used for the last 4 characters of the subdirectory name and the header file name.

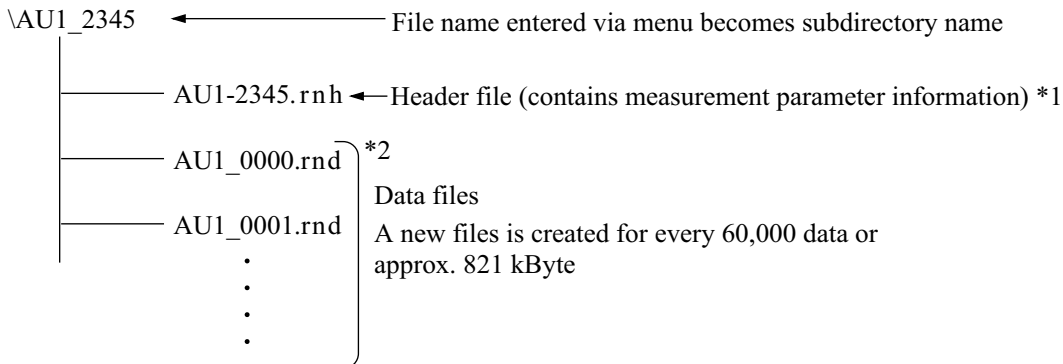

*1 Auto 1 store header file sample

```
File name,    AU1_0002
File number,  2
Data number,  90000
Frequency-weight, A
Time-weight,  Fast
Filter,       Univ.
Center/Lower frequency, Off
Upper frequency, Off
Time setting, 10 sec
Measurement time, 0:00:01
Sampling, 100 msec
Start Time, 2001/02/22 11:25:30
Stop Time, 2001/02/22 11:26:00
```

*2 Auto 1 file description

```
36.9,_,_,_ → Sound pressure level, overload information,
34.8,_,_,_   underload information, pause information
93.9,O,_,_
92.8,O,_,_
31.9,_,_,_
29.1,_,_U,_,_
31.7,_,_,_P, → Pause was pressed before this data set
31.8,_,_,_   (For Leq,1sec, pause was pressed during
31.9,_,_,_   measurement of this data set)
42.3,_,_,_
·
· → When there is no information, this is padded with spaces
```

The header file contains measurement parameters and other information.

The data file contains the sound pressure level, over-range information ("O"), under-range information ("U"), and pause information ("P") in CSV format.

Line returns are <CR><LF>.

One file contains up to 60,000 data. When this number is exceeded, a new file is created. Up to 120 files (corresponding to 200 hours with 100 ms sampling) can be created.

Auto 2 store

The file name entered via the menu screen is used for the last 4 characters of the subdirectory name and the header file name.

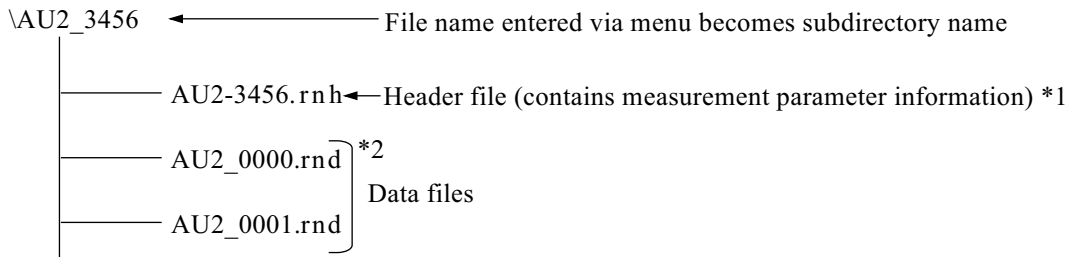

*1 Auto 2 store header file sample

```

File name,    AU2_0002
File number,  1
Data number,  6
Frequency-weight,A
Time-weight,  Fast
Filter,       Univ.
Center/Lower frequency, 12.5 Hz
Upper frequency, 1 kHz
Time setting, 10 sec
Start Time,2001/02/22 11:25:30
Stop Time,2001/02/22 11:26:00
Lx1,L05
Lx2,L10
Lx3,L50
Lx4,L90
Lx5,L95
Ly,*
  
```

*2 Auto 2 file description

```

Address,Time,Measurement Time,LAeq,LAE,LAMax,LAMin,LA05,LA10,LA50,LA90,LA95,*, Over,Under,Pause
1,2001/02/27 12:34:06,0:00:10, 36.5,49.4,48.6,30.3,41.6,40.2,31.3,30.8,30.7,0.0,-,-,-
2,2001/02/27 12:34:16,0:00:10, 35.9,50.1,38.9,37.8,45.6,42.6,39.3,37.7,35.3,0.0,-,-,-
3,2001/02/27 12:34:26,0:00:10, 33.3,52.5,42.4,36.4,42.5,38.3,35.6,33.1,32.2,0.0,-,-,-
4,2001/02/27 12:34:36,0:00:10, 40.1,44.4,47.4,35.5,40.6,38.8,37.5,33.8,30.7,0.0,-,-,-
5,2001/02/27 12:34:46,0:00:10, 38.5,56.4,58.6,30.3,52.9,50.2,41.7,35.3,32.6,0.0,-,-,-
6,2001/02/27 12:34:56,0:00:10, 44.5,46.4,49.9,30.6,43.3,40.7,36.5,33.3,31.1,0.0,-,-,-
  
```

A new file is created for every 60,000 data sets. Because the maximum is 99,999 data sets, there will not be more than 2 files.

For 99,999 Auto 2 store data sets (maximum), approximately 120 Bytes of free space per 1 data set are required.

Default Settings

The factory default settings of the unit are listed below.

Fast/Slow (time weighting)	Fast
A/C/FLAT (frequency weighting)	A
Level Range	30 to 120
Mode	L_p
Store Mode	Manual
Meas. Time	10 min
Auto 1	100 ms
Timer mode	Off
Back Erase	Off
LCD Contrast	***** --
I/O Baud Rate	19200 bps
Index	1
Comp. Level	Off
Output AC/DC	AC
Light Auto Off	5 min
L_{eq}	On
L_{50}	On
L_E	Off
$L_{05}, L_{10}, L_{90}, L_{95}$	Off
L_{max}, L_{min}	Off
Auxiliary processing	Off
LIST	On
T-L	On

When you turn power to the unit on while holding down the Start/Stop key, the unit will be initialized to the above settings. The time and memory contents are not reset.

Output Connectors

AC Output

An AC signal corresponding to the frequency-weighted signal is output. When the optional filter is installed, the output signal corresponds to the signal routed through the filter.

Output voltage: 1 Vrms \pm 50 mV rms (scale upper limit)

Output impedance: approx. 600 Ω

Load impedance: 10 k Ω or higher

Suitable cable: BNC-to-RCA cable CC-24 (option)

The relationship between unit reading and output voltage is as follows.

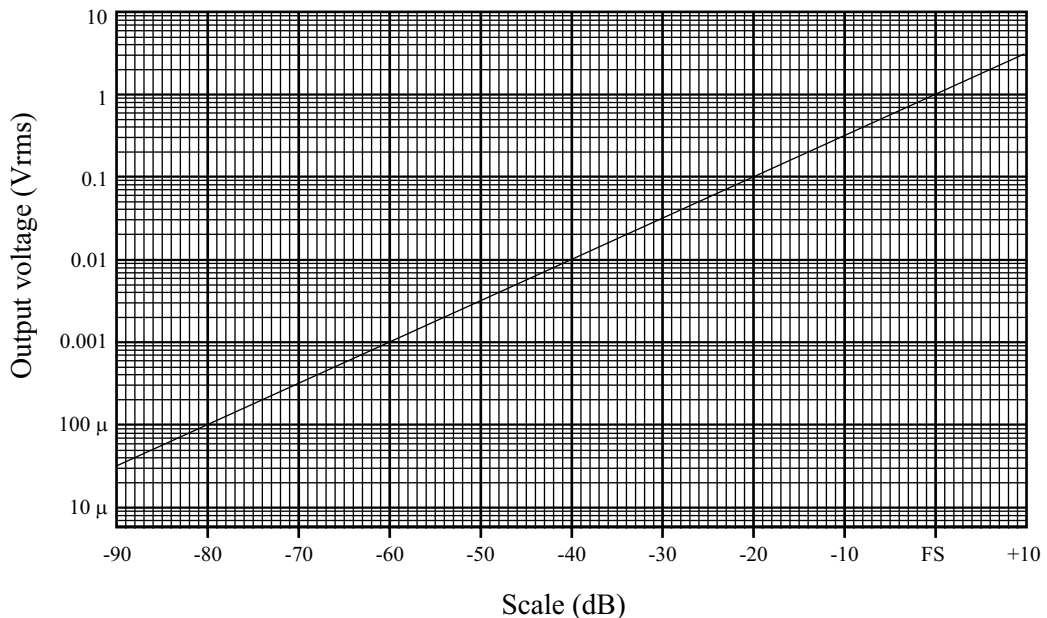

FS: Full-scale value

The output voltage when the unit is in calibration mode (-6 dB from scale upper limit, 1000 Hz sine wave) is 0.5 Vrms.

To use the AC output, set the item "Output AC/DC" on menu screen 3/5 to "AC".

DC Output

A level-converted DC signal generated by rms detection and logarithmic compression is output. The signal reflects the frequency weighting and time weighting settings of the unit.

Output voltage:	2.5 V \pm 50 mV (scale upper limit), 0.25 V / 10 dB
Output impedance:	approx. 50 Ω
Load impedance:	10 k Ω or higher
Suitable cable:	BNC-to-RCA cable CC-24 (option)

The relationship between unit reading and output voltage is as follows.

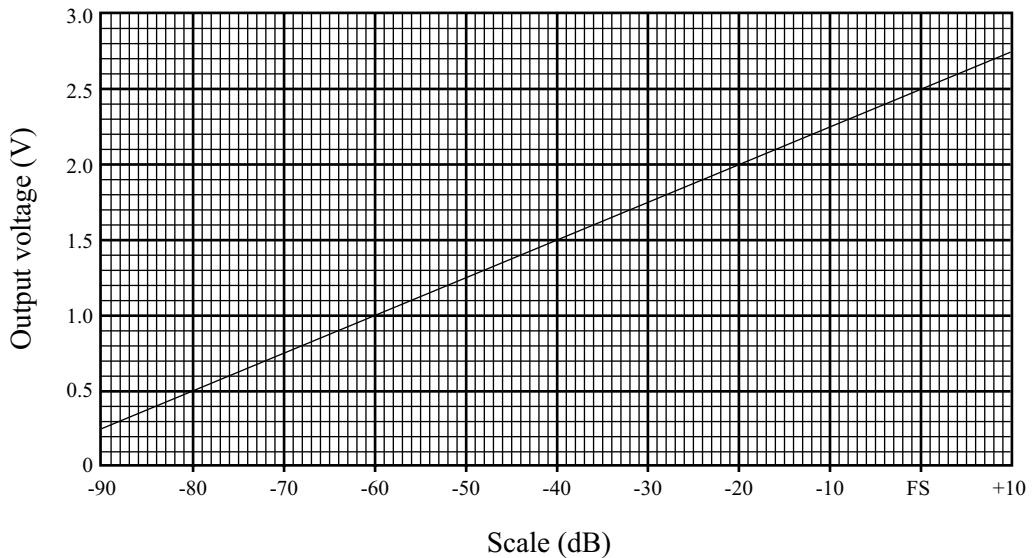

FS: Full-scale value

The output voltage when the unit is in calibration mode (-6 dB from scale upper limit) is 2.35 V.

To use the DC output, set the item "Output AC/DC" on menu screen 3/5 to "DC".

I/O Connector

This input/output connector serves for input of control signals and input/output of measurement data.

The following types of cable can be connected.

- Printer cable: CC-93 (for DPU-414)
CC-93A (For CP-10, CP-11)
- Interface cable: CC-92
For communication with a computer
- Comparator output cable: CC-94
When the level set on menu screen 3/5 (page 40) is exceeded, comparator signal is output for at least 1 second.
This is an open collector output.
The level setting range is Off → 30 dB to 130 dB (1-dB steps) → Off
The comparator output diagram is shown below.

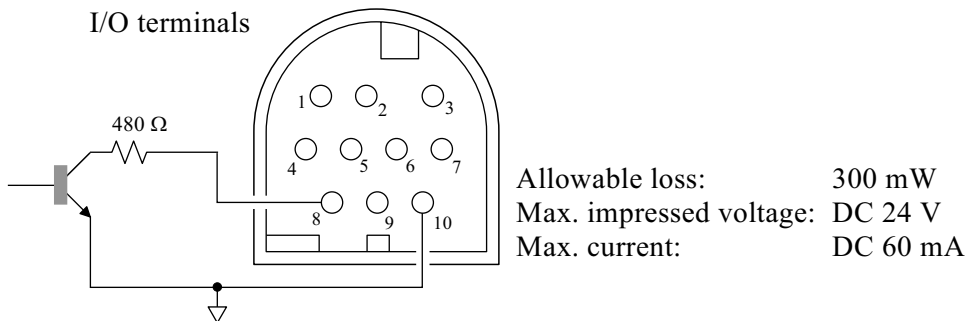

Optional Accessories

Microphone Extension Cables EC-04 Series

For measurements requiring special precision, the microphone can be removed from the main unit and connected by means of an extension cable. This reduces measurement deviations due to refraction effects and the acoustic influence of the operator.

As shown in the table below, six types of cables with a length of 2 to 100 meters are optional. It is also possible to connect several cables in series.

Extension cable EC-04 series

Model	Length	Model	Length
EC-04	2 m	EC-04C	30 m (reel) + 5 m (connection cable)
EC-04A	5 m	EC-04D	50 m (reel) + 5 m (connection cable)
EC-04B	10 m	EC-04E	100 m (reel) + 5 m (connection cable)

Important

With long extension cables, the cable capacitance restricts the upper measurement frequency and measurement level. For details, please refer to the Technical Notes.

Printer DPU-414/CP-11/CP-10

Measurement data shown on the display, as well as data stored in the memory of the unit or on a memory card can be printed out on a connected printer.

The procedure for printing is described below. Before starting, connect the printer to the NL-21/NL-31, turn both units on, and set the printer to the on-line condition. Preparations as described in the chapter "Preparations" (page 10) should also be completed.

Printing out measurement parameters

The contents of the display can be printed out.

1. Press the Menu key to call up the menu screen.
2. Use the Page Up/Down keys to select the page you want to print out (1/5 to 5/5).

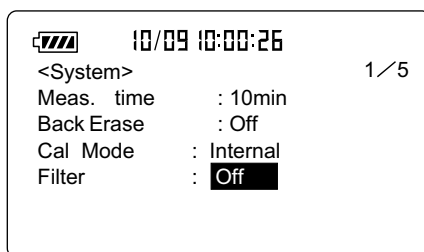
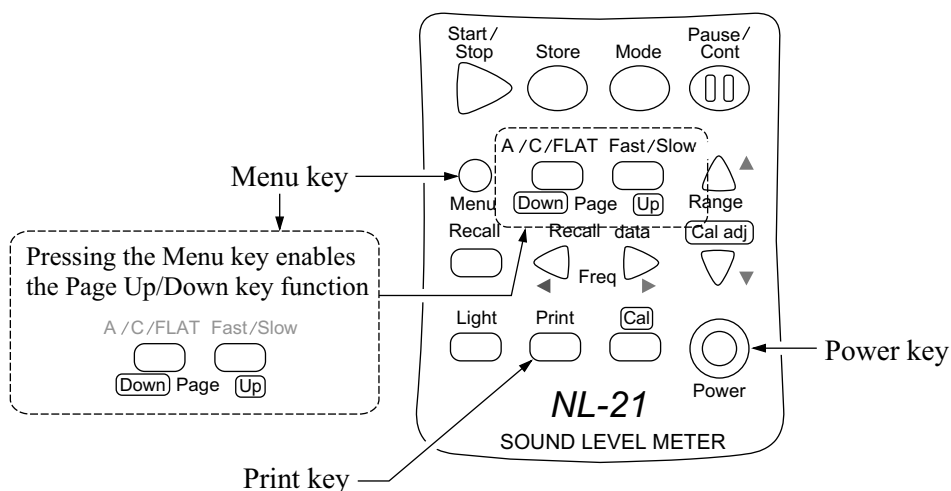

Menu screen example

Menu screen 1/5

3. Press the Print key.

Sample printout

```
<Measurement>      1/5
Meas. time   : 10min
Back Erase   : Off
Cal Mode     : Internal
Filter       : Off
```

Sample printout

Actual font and size will be different.

Printing out data during a measurement (sound level)

A hard copy of the screen is printed out.

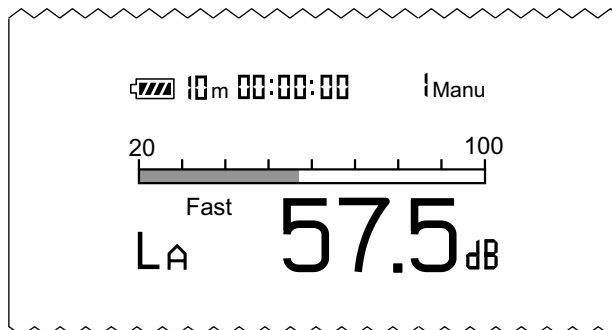

Sample printout

Printing out data stored with manual mode in the internal memory

The following explanation assumes that data have been stored in the memory of the unit. For an explanation of the store process, see the section "Store Operations".

To print out the data, proceed as follows.

1. Verify that the no memory card is inserted in the card slot.
2. Press the Recall key.
3. Use the ◀ and ▶ (Data No.) keys to select the data for printout.

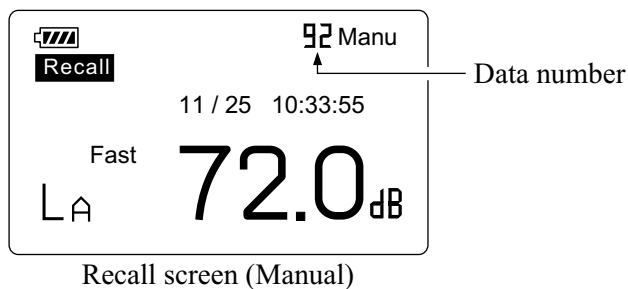

4. Press the Print key.

The printout contents will vary, depending on the contents (sound level value or processed values) shown on the display.

● When processed values are displayed

Example

```

MANU

      1
2000 10/11 12:34:56
LpA 57.0      Fast

2000 10/11 12:30:21      10s      00:00:03
Fast

      LAeq  LAE   LAmax  LAmin  Ly
      57.1  67.1  57.3   57.0  90.7

      LA50  LA10  LA50   LA90  LA95
      57.3  57.2  57.2   57.0  57.0

```

Sample printout

5. To terminate the recall mode, press the Recall key again.

Printing out data stored with Auto 1 mode in the optional memory card

Note

When carrying out Auto 1 and Auto 2 mode, the data cannot be stored in the internal memory.

The following explanation assumes that data have been stored in the optional memory card. For an explanation of the store process, see the section "Store Operations".

To print out the data, proceed as follows.

1. Verify that the memory card is inserted in the card slot.
2. Press the Menu key to call up the menu screen on the display.

The data are sorted by measurement start time, in descending order.

			1
MAN_0001	01/20	13:10	
AU1_1100	01/20	12:15	
AU2_0001	01/22	15:00	
AU1_0002	01/23	08:30	
Memory left	3244k		
OK	Recall	Close	Pause

Card recall screen

3. Use the Page Up/Down keys to go to the page with the desired file name.
4. Use the ▲ and ▼ keys to highlight the desired file name.
5. Press the Recall key.

The data of the selected file are shown on the display.

6. Use the ◀ and ▶ keys to select the data for printout.

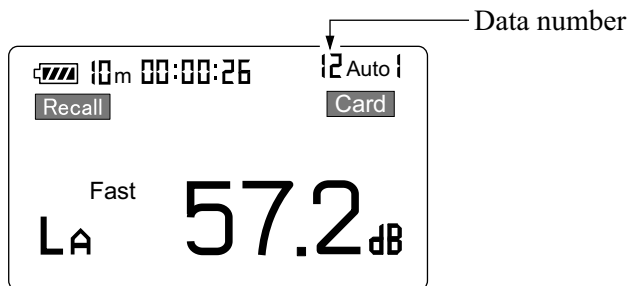

Recall screen (Auto 1)

7. Press the Print key.

100 data sets, starting with the selected data, will be printed out.

Example

```

Auto 1 AU1_0001
2000 10/11 01:23:45 00:01:33 00:00:00
LpA Fast 100ms step
57.2 57.2 57.2 57.2 57.1
57.1 57.1 57.1 57.1 57.1
57.1 57.1 57.1 57.1 57.1
57.1 57.1 57.1 57.0 57.0
57.0 57.0 57.0 57.0 57.0
57.0 57.0 57.0 57.0 57.0
57.0 57.0 57.0

```

Sample printout

If the following conditions have occurred, the alphabet or the mark as shown below is printed after the sound level.

Over:	O
Under:	U
Pause:	P
Pause and Over:	#
Pause and Under:	*

Note

Pressing the Print key increments the data number by 100. Therefore you can print all stored measurement values simply by repeatedly pressing the Print key.

8. To terminate the recall mode, press the Recall key or Pause key. Then press the Pause key.

Printing out data stored with Auto 2 mode in the optional memory card

The following explanation assumes that data have been stored in the optional memory card. For an explanation of the store process, see the section "Store Operations".

To print out the data, proceed as follows.

1. Verify that the memory card is inserted in the card slot.
2. Press the Recall key to bring up the card recall screen.

The data are sorted by measurement start time, in descending order.

[Battery Icon]			1
MAN_0001	01/20		13:10
AU1_1100	01/20		12:15
AU2_0001	01/22		15:00
AU1_0002	01/23		08:30
Memory left	3244k		
OK	Recall	Close	Pause

Card recall screen

3. Use the Page Up/Down keys to go to the page with the desired file name.
4. Use the ▲ and ▼ keys to highlight the desired file name.

[Battery Icon]		10/09 10:00:26	2/5
<Store>			
Store mode :	Auto2 (Leq)	←	Store mode
File name :	AU2_1234		

Menu screen 2/5

5. Press the Recall key.

The data of the selected file are shown on the display.

6. Use the ◀ and ▶ keys to select the data for printout.

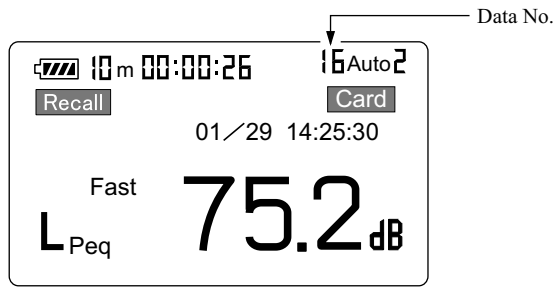

Recall screen (Auto 2)

7. Press the Print key.

Example

Auto 2 AU2_0001					
Fast					
	LAeq	LAE	LAmx	LAmn	LCeq
	LA05	LA10	LA50	LA90	LA95
2000	10/11	01:23:45		00:00:10	
1	57.1	67.1	57.3	57.0	90.7
	57.2	57.2	57.1	57.0	57.0
2000	10/11	01:23:55		00:00:10	
2	57.1	67.1	57.3	57.0	90.7
	57.2	57.2	57.1	57.0	57.0
2000	10/11	01:24:05		00:00:10	
3	57.1	67.1	57.3	57.0	90.7
	57.2	57.2	57.1	57.0	57.0
⋮	⋮	⋮	⋮	⋮	⋮
⋮	⋮	⋮	⋮	⋮	⋮
⋮	⋮	⋮	⋮	⋮	⋮
2000	10/11	01:25:05		00:00:10	
10	57.1	67.1	57.3	57.0	90.7
	57.2	57.2	57.1	57.0	57.0

Sample printout

Auxiliary processing value
(It is not printed out when Off is chosen.)

When the Print key is pressed for the first time, 50 data sets starting from the selected data number are printed out.

The next time the key is pressed, the subsequent 50 data sets are printed out.

8. To terminate the recall mode, press the Recall key or Pause key. Then press the Pause key.

Level Recorder LR-06/LR-07/LR-04/LR-20A

For continuous recording of noise level changes, a level recorder can be connected to the unit.

Sound level recording

The procedure for noise level recording on a level recorder is described below. Before starting, connect the level recorder to the NL-21/NL-31 and turn power on. Preparations as described in the chapter "Preparations" (page 20) must also be completed. For details regarding use of the level recorder, please refer to its documentation.

1. Call up the menu screen 1/5 and verify that the "Cal Mode" item is set to "Internal". If "External" is shown, use the ▲ and ▼ keys to move the cursor to "External" and use the ◀ and ▶ keys to set it to "Internal".
2. Use the Page Up/Down keys to display the menu screen 3/5.
3. Set the "Output AC/DC" item to "AC".
When the setting is complete, press the Menu key to return to the measurement screen.
4. Press the Cal key to set the unit to the calibration mode.
5. Activate the paper feed and pen operation of the level recorder to start recording.
6. Adjust the level control (Level adj) of the level recorder so that the pen is at a point -6 dB below the full-scale point.

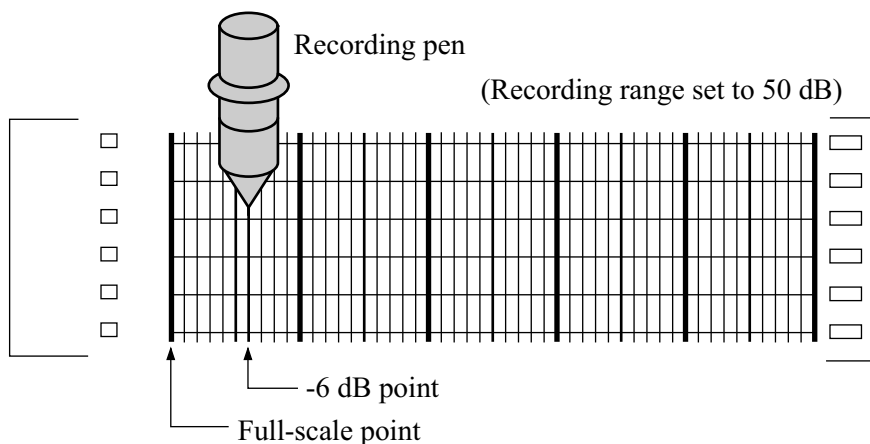

7. Press the Cal key once more to return to the measurement mode.
8. Use the A/C/FLAT key to set the frequency weighting. The time weighting is adjusted at the level recorder.
9. Use the Level Range keys to select the level range. Choose a setting in which the "Over" or "Under" indication does not appear. The upper limit of the level range selected at the NL-21/NL-31 becomes the full-scale point of the level recorder.

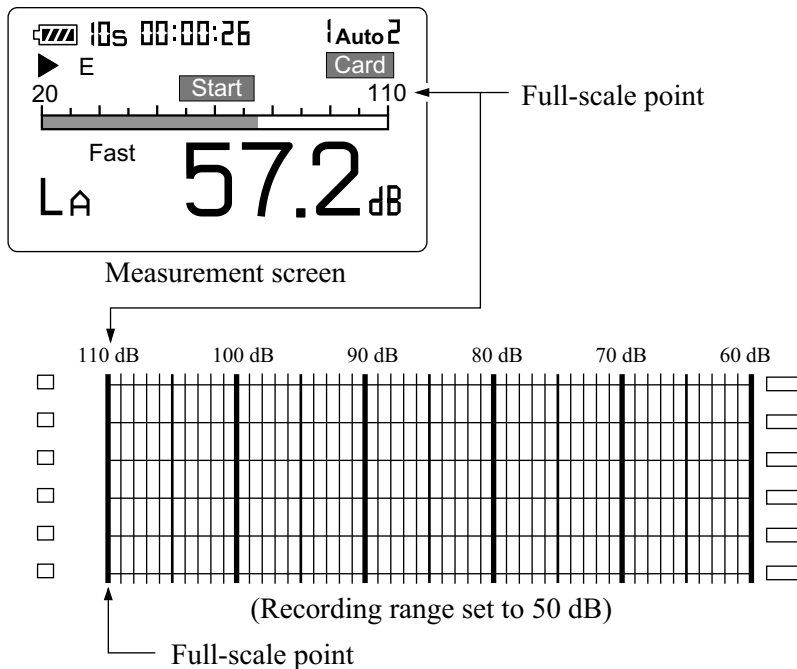

Program Cards

A 1/1, 1/3 octave filter program card and a universal filter program card are available as options. A program card is a CompactFlash memory card which contains program data. After these program data have been read off the card by the sound level meter during the software installation process, the new function can be used.

The meanings of the words used in this chapter

- Load (sound level meter): To incorporate the program to sound level meter.
- Unload (sound level meter): To remove the program from sound level meter.
- Loaded (card): The card is used for loading the program to sound level meter and cannot be used for the other sound level meters.
- Unloaded (card): The card is not used for loading the program to sound level meter (factory default).

The software on the program card are protected, to ensure that the card cannot be used for several sound level meters simultaneously. The software from only one program card can be loaded into the NL-21/NL-31.

Loading and unloading the program from a program card

Important

Make sure that power to the NL-21/NL-31 is turned off before starting the load procedure.

Make sure the following points before loading/unloading the program to sound level meter.

When loading:

- Other program is not loaded to the sound level meter (see page 37).
- The program card is not used (unloaded) for loading the program to sound level meter.

When unloading:

- The program is loaded to the sound level meter (see page 37).
- The program card is used (loaded) for loading program to sound level meter.
- The kind of the program is the same one which will be unloaded (see page 37).

Note

When loading the program and unloading the program, the procedure is the same as follows.

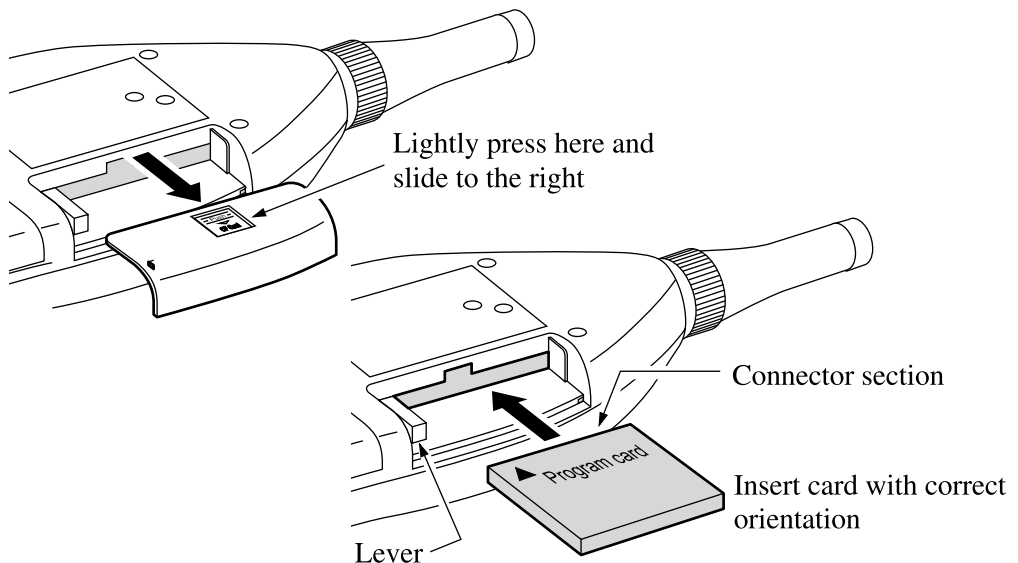

1. Open the card compartment and insert the program card.

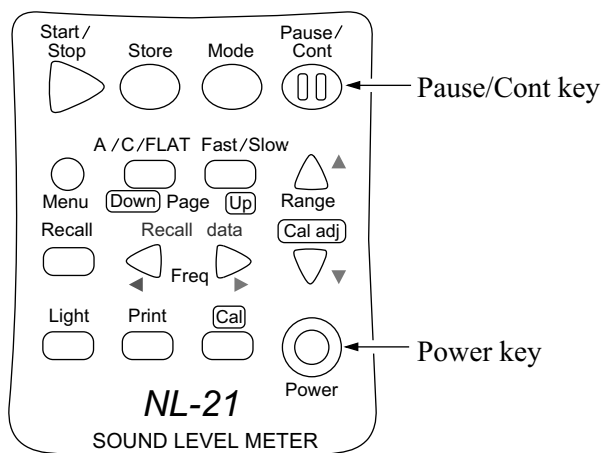

2. Hold down the Pause/Cont key while pressing the Power key to turn on the unit.
3. While the card is being checked and the software is loaded, the indication below is shown.

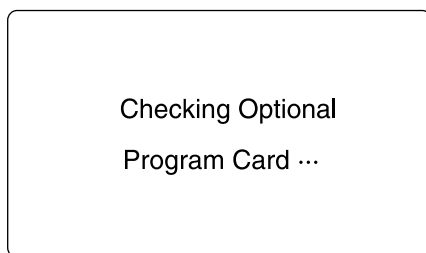

Program load display

4. When the program was loaded correctly, the indication below is shown.
 - Universal filter was loaded (incorporated in sound level meter)
The card was used for loading the program (loaded) and cannot be used to load the program to another sound level meter.
" Universal
filter program
has loaded.
Push any key"

- Universal filter was unloaded (removed from sound level meter)
The card was not used for loading the program (unloaded) and can be used to load the program to sound level meter.
" Universal
filter program
has unloaded.
Push any key "
- 1/1, 1/3 octave filter was loaded (incorporated in sound level meter)
The card was used for loading the program (loaded) and cannot be used to load the program to another sound level meter.
" 1/1 & 1/3oct.
filter program
has loaded.
Push any key "
- 1/1, 1/3 octave filter was unloaded (removed from sound level meter)
The card was not used for loading the program (unloaded) and can be used to load the program to sound level meter.
" 1/1 & 1/3oct.
filter program
has unloaded.
Push any key "

5. To remove the card, push the lever.

Note
When a program card was used once for loading the software, protection is activated automatically. Unless the software is unloaded again from the same sound level meter, the card cannot be used to load the software to another sound level meter.

Important
Never remove the card while the indication "Checking Optional Program Card" is shown. Otherwise the card can be damaged.

If an error occurs during loading

If an error has occurred while the software is being loaded, the following indication is shown.

- If a memory content mismatch was detected during the load or unload process.
- If software from another program card was already loaded into the sound level meter.
 - " This is not a RION
program card.
Push any key "
- If the contents were already loaded to another sound level meter.
 - " This program has
already loaded to
other unit.
Push any key "

1/1, 1/3 Octave Filter Card NX-21SA

Linearity range during filter operation is 65 dB.

Supported standard: IEC 61260:1995 Class 1

1/1 octave filters (IEC compatible)

Installed in NL-21: 16 Hz to 8 kHz

Installed in NL-31: 16 Hz to 8 kHz

1/3 octave filters (IEC compatible)

Installed in NL-21: 12.5 Hz to 10 kHz

Installed in NL-31: 12.5 Hz to 16 kHz

Select the "Filter" item on menu screen 1/5, and set it to "1/1 oct" or "1/3 oct".

Use the frequency keys to switch the center frequency.

The ◀ key shifts the center frequency to the next lower band.

The ▶ key shifts the center frequency to the next higher band.

The menu screen 1/5 can also be used to switch the center frequency.

1/1 oct band filter

AP (all-pass) ⇔ 16 Hz ⇔ 31.5 Hz ⇔ 63 Hz ⇔ 125 Hz ⇔ 250 Hz ⇔
500 Hz ⇔ 1 kHz ⇔ 2 kHz ⇔ 4 kHz ⇔ 8 kHz ⇔ AP (all-pass)

1/3 oct band filter

AP (all-pass) ⇔ 12.5 Hz ⇔ 16 Hz ⇔ 20 Hz ⇔ 25 Hz ⇔ 31.5 Hz ⇔
40 Hz ⇔ 50 Hz ⇔ 63 Hz ⇔ 80 Hz ⇔ 100 Hz ⇔ 125 Hz ⇔ 160 Hz ⇔
200 Hz ⇔ 250 Hz ⇔ 315 Hz ⇔ 400 Hz ⇔ 500 Hz ⇔ 630 Hz ⇔ 800 Hz ⇔
1 kHz ⇔ 1.25 kHz ⇔ 1.6 kHz ⇔ 2 kHz ⇔ 2.5 kHz ⇔ 3.15 kHz ⇔
4 kHz ⇔ 5 kHz ⇔ 6.3 kHz ⇔ 8 kHz ⇔ 10 kHz ⇔ [12.5 kHz ⇔ 16 kHz] ⇔
AP (all-pass)

12.5 kHz and 16 kHz can be set only for NL-31.

Each key press shifts the frequency by one step.

Important

Auxiliary processing and the optional filter (octave filter, universal filter) cannot be used together.

When the 1/1 octave filter, 1/3 octave filter, or universal filter is set to "On", auxiliary processing will not work. You should therefore set the auxiliary processing function on the display menu screen 4/5 to "Off".

Universal Filter Card NX-21VA

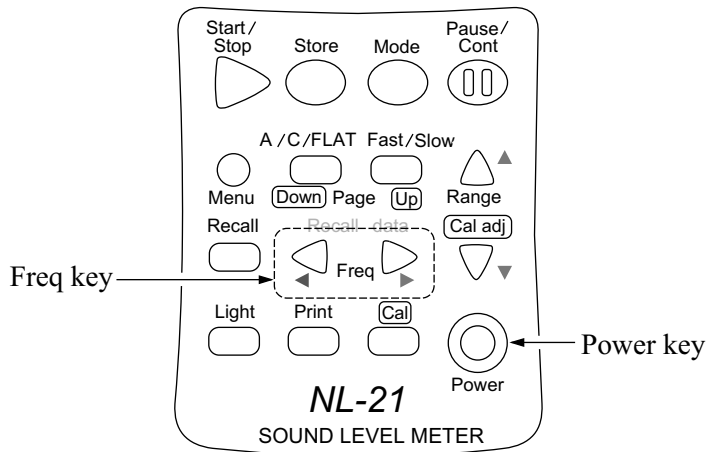

3rd-order Butterworth high-pass filter and 3rd-order Butterworth low-pass filter with freely selectable frequency in 1/3 octave steps

Linearity range during filter operation is 65 dB.

HPF cutoff frequencies (-3 dB)

Installed in NL-21: 10 Hz to 8 kHz

Installed in NL-31: 10 Hz to 12.5 kHz

LPF cutoff frequencies (-3 dB)

Installed in NL-21: 10 Hz to 8 kHz

Installed in NL-31: 10 Hz to 12.5 kHz

Select the "Filter" item on menu screen 1/5, and set it to "Univ".

Use the frequency keys to switch the cutoff frequency (1/3 octave steps).

The ◀ key shifts the frequency (high-pass filter cutoff frequency) to the next higher band.

NO ⇒ 10 Hz ⇒ 12.5 Hz ⇒ 16 Hz ⇒ 20 Hz ⇒ 25 Hz ⇒ 31.5 Hz ⇒ 40 Hz
 ⇒ 50 Hz ⇒ 63 Hz ⇒ 80 Hz ⇒ 100 Hz ⇒ 125 Hz ⇒ 160 Hz ⇒ 200 Hz
 ⇒ 250 Hz ⇒ 315 Hz ⇒ 400 Hz ⇒ 500 Hz ⇒ 630 Hz ⇒ 800 Hz ⇒ 1 kHz
 ⇒ 1.25 kHz ⇒ 1.6 kHz ⇒ 2 kHz ⇒ 2.5 kHz ⇒ 3.15 kHz ⇒ 4 kHz ⇒ 5 kHz
 ⇒ 6.3 kHz ⇒ 8 kHz [⇒ 10 kHz ⇒ 12.5 kHz] ⇒ NO

10 kHz and 12.5 kHz can be set only for NL-31.

The ▶ key shifts the frequency (low-pass filter cutoff frequency) to the next higher band.

NO ⇒ 10 Hz ⇒ 12.5 Hz ⇒ 16 Hz ⇒ 20 Hz ⇒ 25 Hz ⇒ 31.5 Hz ⇒ 40 Hz
 ⇒ 50 Hz ⇒ 63 Hz ⇒ 80 Hz ⇒ 100 Hz ⇒ 125 Hz ⇒ 160 Hz ⇒ 200 Hz
 ⇒ 250 Hz ⇒ 315 Hz ⇒ 400 Hz ⇒ 500 Hz ⇒ 630 Hz ⇒ 800 Hz ⇒ 1 kHz
 ⇒ 1.25 kHz ⇒ 1.6 kHz ⇒ 2 kHz ⇒ 2.5 kHz ⇒ 3.15 kHz ⇒ 4 kHz ⇒ 5 kHz
 ⇒ 6.3 kHz ⇒ 8 kHz [⇒ 10 kHz ⇒ 12.5 kHz] ⇒ NO

The setting shown in brackets (NO, 10 kHz, 12.5 kHz) can be set only for the NL-31.

Each key press shifts the frequency by one step.

Filter cutoff frequency can be changed on the menu screen.

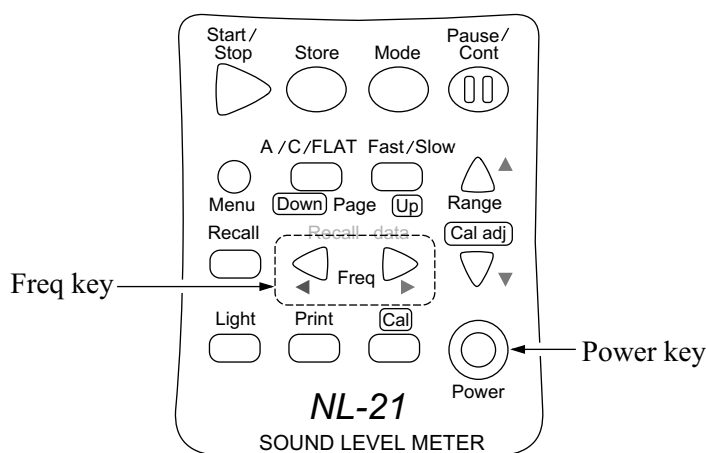

Important

If the optional filter is set to "On", auxiliary processing cannot be used. The auxiliary processing value will be 00.0 dB even if the function is set to "On".

However, if the filter is set to "On" but "AP" (octave filter) or "Off-Off" (universal filter) is selected, auxiliary processing can be used, because the filter does not operate at these settings.

Messages

This chapter explains various messages that may be displayed by the unit during operation. Any steps that should be taken are also explained.

English

Deutsch

Español

File open error

Can not open file
or memory full!
Push any key.

Datei kann nicht
geöffnet werden!
Taste drücken.

No se puede abrir
archivo o lleno.
Presione un botón.

Store was attempted on a memory card with insufficient capacity, or on an incompatible memory card.

<User action>

Use a different card, or delete data from the card.

File overwrite confirmation

Same file exists!!

Overwrite?
OK→ [Start]
Cancel→ [Pause]

Datei existiert
bereits!
Überschreiben?
OK→ [Start]
Cancel→ [Pause]

Ya existe ese
archivo.
Sobreescribir?
OK→ [Start]
Cancel→ [Pause]

A file with the same name exists already.

<User action>

Change the file name via the menu screen, or overwrite older file.

No card error

No card!!

Push any key.

Keine Karte
eingelegt!
Taste drücken.

Sin tarjeta.

Presione un botón.

Auto store or manual store on memory card was attempted while no card was inserted.

<User action>

Insert a memory card.

Card read error

Error in reading from card! Push any key.	Lesefehler von Karte! Taste drücken.	Error de lectura en tarjeta! Presione un botón.
---	--	---

Data read was attempted, but card was removed.

<User action>

Do not remove card during read or write access.

Card write error

Error in writing to card! Push any key.	Schreibfehler auf Karte Taste drücken.	Error de escritura en tarjeta! Presione un botón.
---	--	---

Card has become full during Auto store, or data write was attempted, but card was removed.

<User action>

Do not remove card during read or write access. (Data on a removed card may not accurately reflect measurement data.)

Not able to format

Could not format! Push any key.	Karte kann nicht formatiert werden! Taste drücken.	No se pudo formatear! Presione un botón.
--	---	--

A card that cannot be formatted in the unit was inserted.

<User action>

Format the card in a computer.

Formatting message

Formatting card...	Karte wird formatiert...	Está formateando la tarjeta...
--------------------	-----------------------------	-----------------------------------

Memory card is being formatted.

No recall data

No recall data!	Keine gespeicherte Daten vorhanden!	No hay datos que recuperer.
Push any key.	Taste drücken.	Presione un botón.

There are no data stored on the memory card.

Recall data are being checked

Checking card...	Karte wird geprüft...	Está comprobando la tarjeta...
Cancel→[Pause]	Cancel→[Pause]	Cancel→[Pause]

Data stored on the memory card are being test-read.

Auto store end

Data memory full.	Datenspeicher voll.	Memoria de datos llena.
Aborting this measurement	Diese Messung wird abgebrochen.	Está medición está interrumpida.
Push any key.	Taste drücken.	Presione un botón.

200 hours were reached (Auto 1) or 99,999 data sets were reached (Auto 2).

Data number 100 reached during manual store (internal memory)

Data memory full.	Datenspeicher voll.	Memoria llena.
Make other store name.	Anderen Speichernamen wählen.	Poner otro nombre para almacenar.
Push any key.	Taste drücken.	Presione un botón.

100 addresses were reached during manual store in internal memory, or address number is 100.

<User action>

Change address to lower number and overwrite, or specify a new file name via the menu screen and start from address 1.

Data number 100 reached during manual store (memory card)

Data count has reached 100.	Datensnummer 100 erreicht.	Contador de datos ha llegado a no 100
Change Data Number.	Datensnummer ändern.	Cambiar no de dato.
Push any key.	Taste drücken.	Presione un botón.

100 addresses were reached during manual store on memory card, or address number is 100.

<User action>

Change address to lower number and overwrite.

Timer mode end

Timer mode Measurement is completed.	Timer-Modus-Messung beendet.	Medición en modo temporizador está completada.
Push any key.	Taste drücken.	Presione un botón.

Measurement in timer mode has ended.

Invalid operation

Invalid operation!	Bedienungsfehler!	Operación no válida
--------------------	-------------------	---------------------

For example, this message appears when main display shows frequency C-weighting and sub display (auxiliary processing value) is set to L_{AI} etc.

<User action>

Make appropriate settings for measurement conditions. (To measure L_{AI} set main display also to A weighting.)

Timer mode setting error

Reset interval time or measurement time.	Intervalldauer oder Meßdauer neu eingeben.	Resetear intervalo de tiempo.
---	--	----------------------------------

Settings are inconsistent.		Ajuste de intervalo inconsistente.
-------------------------------	--	---------------------------------------

Push any key.	Taste drücken.	Presione un botón.
---------------	----------------	--------------------

Measurement time is longer than interval time for timer mode.

<User action>

Set measurement time to a shorter value than interval time for timer mode.

Auto 2 store measurement time error

Invalid measurement time.	Ungültige Meßdauer.	Tiempo de medición no válido.
------------------------------	---------------------	----------------------------------

Reset measurement Time	Meßdauer neu eingeben.	Resetear el tiempo de medición.
---------------------------	---------------------------	------------------------------------

Push any key.	Taste drücken.	Presione un botón.
---------------	----------------	--------------------

Menu screen "Meas. time" item is set to "Manual" but Auto 2 store was attempted.

<User action>

Set "Meas. time" to value other than "Manual".

Battery problem

Battery is dead.	Batterie ist leer.	Batería agotada.
Auto shutdown is executed.	Gerät schaltet sich automatisch ab.	De-conexión automatica ejecutada

The remaining battery capacity is very low.

<User action>

Replace batteries.

Specifications

Applicable standards

Sound Level Meter NL-21

IEC 61672-1:2002 Class 2

JIS C 1509-1:2005 Class 2

IEC 60651 and IEC 60804 was withdrawn and replaced by IEC 61672-1:2002.

JIS C 1502 was withdrawn and replaced by JIS C 1509-1.

Sound Level Meter NL-31

IEC 61672-1:2002 Class 1

JIS C 1509-1:2005 Class 1

IEC 60651 and IEC 60804 was withdrawn and replaced by IEC 61672-1:2002.

JIS C 1505 was withdrawn and replaced by JIS C 1509-1.

Measurement functions

Main processing functions

Simultaneous measurement of all items according to selected time weighting and frequency weighting

Sound level L_p

Equivalent continuous sound level L_{eq}

Sound exposure level L_E

Maximum sound level L_{max}

Minimum sound level L_{min}

Percentile sound level L_N (5 selectable settings)

Auxiliary processing functions

One selectable for simultaneous processing with main measurement processing functions

Peak sound level (FLAT) L_{peak}

C-weighted peak sound level L_{Cpeak}

C-weighted equivalent continuous sound level L_{Ceq}

Power average of maximum sound level in a given interval L_{Atm5}

Impulse sound level L_{AI}

Impulse equivalent continuous sound level L_{A1eq}

L_{A1m5} , L_{AI} , and L_{A1eq} can only be chosen when A weighting is selected for main processing.

L_{CEq} can only be chosen when A weighting or FLAT is selected for main processing.

Measurement time

10 seconds, 1, 5, 10, 15, 30 minutes, 1, 8, 24 hours, and manual (maximum 200 hours)

Measurement range

A weighting: 28 dB to 138 dB

C weighting: 33 dB to 138 dB

FLAT: 38 dB to 138 dB

C-weighted peak sound level: 55 dB to 141 dB

Peak sound level (FLAT): 60 dB to 141 dB

Noise floor

NL-21 NL-31

A weighting: 22 dB or less 20 dB or less
(19 dB Typ.) (17 dB Typ.)

C weighting: 27 dB or less 25 dB or less

Flat: 32 dB or less 30 dB or less

Linearity range

100 dB

Reference sound pressure level

94 dB

Reference level range

30 to 120 dB

Level range selection

6 ranges in 10-dB steps

20 to 80 dB

20 to 90 dB

20 to 100 dB

20 to 110 dB

30 to 120 dB

40 to 130 dB

(7 ranges when optional 1/1, 1/3 Octave Filter Card NX-21SA or optional Universal Filter Card NX-21VA is ON)

10 to 70 dB (selectable only when NX-21SA or NX-21VA is ON)

20 to 80 dB

30 to 90 dB

40 to 100 dB

50 to 110 dB

60 to 120 dB

70 to 130 dB

Frequency range

Overall characteristics including microphone:

NL-21: 20 to 8000 Hz NL-31: 20 to 20000 Hz

Electrical circuit characteristics (AC output):

NL-21: 10 to 20000 Hz NL-31: 10 to 20000 Hz

Electrical circuit characteristics (detector):

NL-21: 10 to 20000 Hz NL-31: 10 to 20000 Hz

Frequency weighting A, C, FLAT

RMS detection Digital processor

Characteristics: Fast, Slow, Impulse*

* Impulse is selectable only for auxiliary processing functions

Calibration

Electrical calibration with 1-kHz sine wave signal from built-in oscillator

Calibration using sound calibrator or pistonphone

Back-erase function

Pause key can be set to erase data from preceding 5 seconds

Processing functions

Digital processing

Sampling interval

NL-21: 30.3 μ s (L_{eq} , L_{max} , L_{min} , L_E)
 100 ms (L_N)

NL-31: 20.8 μ s (L_{eq} , L_{max} , L_{min} , L_E)
 100 ms (L_N)

Data store functions

For manual store, data can be stored either in the internal memory or on the CompactFlash memory card. Auto store is possible only when the optional memory card is inserted, because data are stored directly on the card. Multiple data files can be created on the memory card.

Manual store: Up to 100 data sets (sound level, store time and date, main and auxiliary processing results, processing start time) can be stored manually. Maximum expands to 100 data sets per one file when storing directly to memory card.

Auto store 1 timer function:

Serves to set start and end time for auto store 1 measurement. Until the measurement start time, the unit operates in power save mode (power consumption approx.1/3).

Auto store 1: Sound level or $L_{Aeq,1\text{ sec}}$ can be stored automatically on memory card every 100 ms, 200 ms, or 1 s. The maximum store time is 200 hours.

Auto store 2: Main and auxiliary processing results and processing start time are stored on memory card for each measurement, performed at preset intervals. Max. 99999 data sets can be stored.

Auto store 2 timer function:

Serves to set start and end time for auto store 2 measurement. Pause interval between measurements can also be set. During the pause interval, the unit operates in power save mode (power consumption approx.1/3).

Microphone and preamplifier

1/2-inch prepolarized condenser type

	NL-21	NL-31
Model:	UC-52	UC-53A
Sensitivity:	-33 dB	-28 dB

Preamplifier NH-21

Display

Backlit LCD (128 × 64 dots + 121 icons)

Display screens

Numeric and bar graph indication of sound level

Processing results screen

Level-time graph (real-time level recording with 20-second horizontal axis)

Menu screens for operation settings

Warning indications

Over-range indication: full-scale +8.5 dB

Under-range indication: full-scale -2.6 dB

Outputs

AC/DC output Key-selectable AC or DC output

AC output (using selected frequency weighting and filter settings)

Output voltage: 1 V_{rms} (at full-scale)

Output impedance: 600 Ω

Load impedance: 10 kΩ or more

DC output

Output voltage: 2.5 V (at full-scale), 0.25 V/10 dB

Output impedance: 50 Ω

Load impedance: 10 kΩ or more

I/O connector

Sound level meter control from and data output to a computer

Data output to printer DPU-414/CP-11/CP-10

RS-232-C

Transfer principle:	asynchronous
Data word length:	8 bit
Stop bits:	1 bit
Parity check:	none
Baud rate:	4800, 9600 or 19200 bps
Flow control:	yes
	Select X parameter control or RTS/CTS control

Comparator output

Open collector output; goes ON when set level is exceeded

Maximum voltage:	DC 24 V
Maximum current:	DC 60 mA
Level setting range:	30 to 130 dB, 1-dB steps

Power requirements

Four IEC R6P (size "AA") batteries

Battery life (23°C)

NL-21:	Approx. 32 h (alkaline batteries), 12 h (manganese batteries)
NL-31:	Approx. 27 h (alkaline batteries), 10 h (manganese batteries)

With backlighting, battery life is reduced to about half.

When auxiliary processing functions are enabled, battery life is reduced by about 20%.

When the optional filter is enabled, battery life is reduced by about 20%.

AC adapter (option)

NC-34:	100 V AC
NC-34A:	120 V AC
NC-34B:	220 V AC
NC-98A:	100 to 240 V AC (CE-marked)

Current rating

NL-21: Approx. 55 mA

NL-31: Approx. 65 mA

Current consumption in standby mode is reduced to about one third.

Operating input voltage: 4.2 V to 6.5 V

Internal backup battery retains clock for about 1.5 months without external power

Ambient conditions -10°C to +50°C, 10% to 90% RH (no condensation)

Dimensions Approx. 260 × 76 × 33 mm

Weight Approx. 400 g (including batteries)

Supplied accessories

Windscreen	WS-10	1
Carrying case		
(Product name label, Logo label)	NL-21-031	1
Connector cover (mounted on unit)	NL-21-005	1
Hand strap	VM-63-017	1
Batteries	IEC R6P	4
Inspection Certificate		1
Instruction manuals		1 set
(Instruction Manual, Technical Notes, Serial Interface Manual, 1 each)		

Optional equipment

1/1, 1/3 Octave Filter Card	NX-21SA
Universal Filter Card	NX-21VA
CompactFlash card	MC-16CF
CF card adapter	MC-CFADP
AC adapter	NC-34 series
AC adapter with CE mark	NC-98A (100 to 240 V, 50/60 Hz)
BNC-to-RCA cable	CC-24
Microphone extension cable	EC-04 series
Serial I/O cable	CC-92
Printer cable	CC-93 (for DPU-414) CC-93A (for CP-10, CP-11)
Printer	DPU-414
Sound calibrator	NC-74
Pistonphone	NC-72
Level recorder	LR-07/LR-20A
Comparator output cable	CC-94
Windscreen	WS-03E
Battery pack	BP-21
Dry-cell batteries (IEC-R20, size "D") × 4	

Optional program card specifications

The program card is a CompactFlash card which contains program data. After these program data have been read off the card by the sound level meter during the software installation process, the new function can be used.

The data on the program card are protected, to ensure that the card cannot be used for several sound level meters simultaneously, and to prevent the files from being easily copied in the Windows or MS-DOS environment.

Only one function can be selected for installation in the sound level meter.

1/1, 1/3 Octave Filter Card NX-21SA

Linearity range during filter operation is 65 dB.

Supported standard: IEC 61260 : 1995 Class 1

1/1 octave filters (IEC compatible)

 Installed in NL-21: 16 Hz to 8 kHz

 Installed in NL-31: 16 Hz to 8 kHz

1/3 octave filters (IEC compatible)

 Installed in NL-21: 12.5 Hz to 10 kHz

 Installed in NL-31: 12.5 Hz to 16 kHz

Universal Filter Card NX-21VA

3rd-order Butterworth high-pass filter and 3rd-order Butterworth low-pass filter with freely selectable frequency in 1/3 octave steps

Linearity range during filter operation is 65 dB.

HPF cutoff frequencies (-3 dB)

 Installed in NL-21: 10 Hz to 8 kHz

 Installed in NL-31: 10 Hz to 12.5 kHz

LPF cutoff frequencies (-3 dB)

 Installed in NL-21: 10 Hz to 8 kHz

 Installed in NL-31: 10 Hz to 12.5 kHz

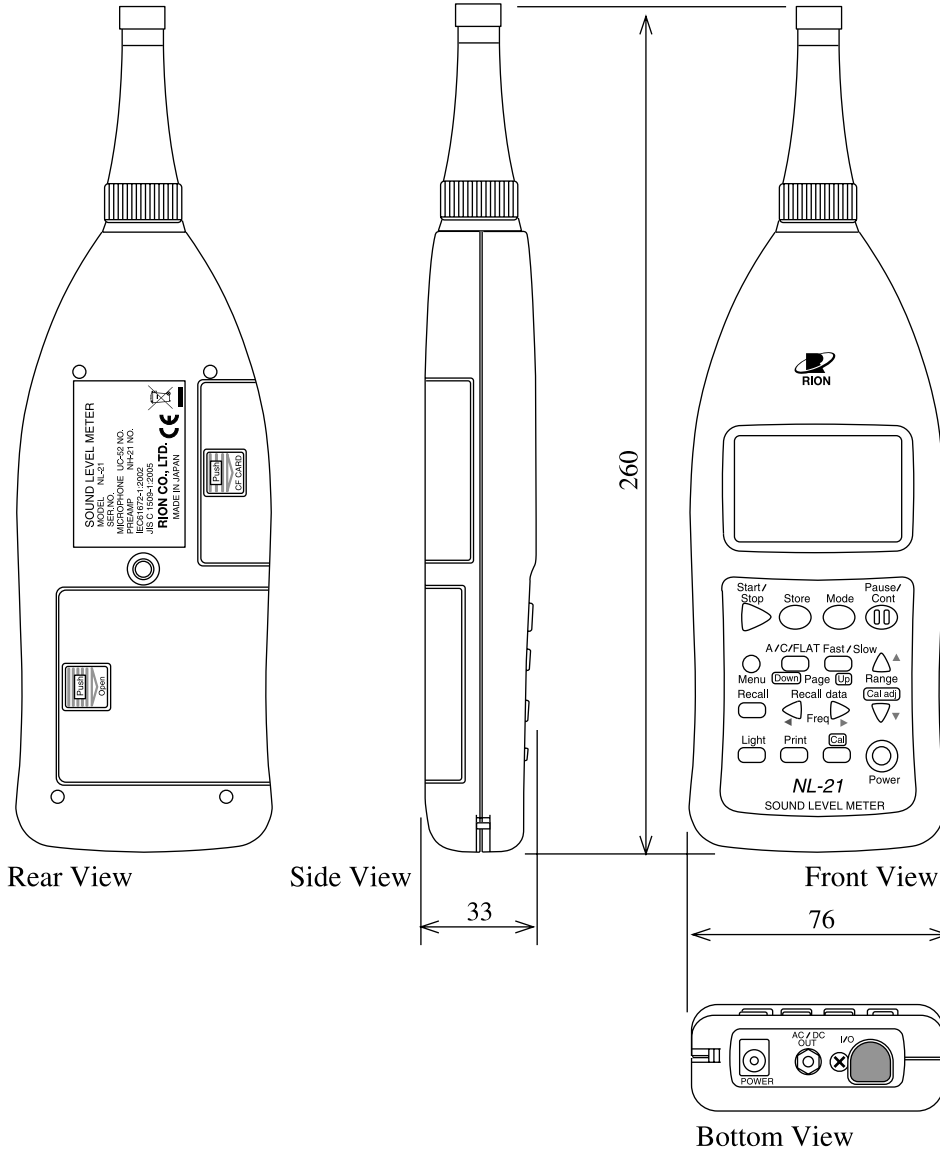

Unit: mm

Dimensional Drawings (Illustration shows NL-21)

